

CLADDING

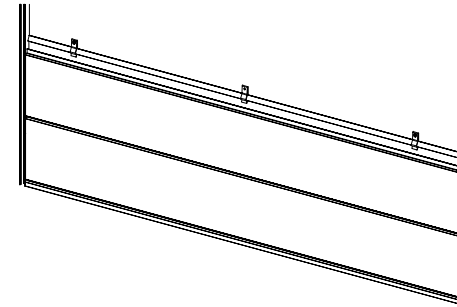

PLANKS

4" [100mm], 6" [150mm], 8" [200mm], 10" [250mm]
Plank

TRIMS

Starter strip
Trim base
J-Trim cover
Long J-Trim cover
Corner profile A
Corner profile B
H-Trim Cover

Standard lengths
19' [5790mm] (usable length 18'9" [5715mm])

CLIPS AND CONNECTORS

Screen clip (100 pcs/bag)
Celloflex gasket (250 pcs/bag)

FASTENING

Stainless steel wood screws with pan head
#9 [4.5mm]
Stainless steel self-drilling screws with round head
#8 [4.2mm]
Stainless steel self-tapping screws with round head
#8 [4.2mm]

FINISHES

Powder-on-powder wood-grain decoration
Sublimated wood-grain decoration
Exclusive digital printed wood-grain decoration
Powder coated
Anodized finish

BIM&CAD

RVT&DWG files available, see website for details

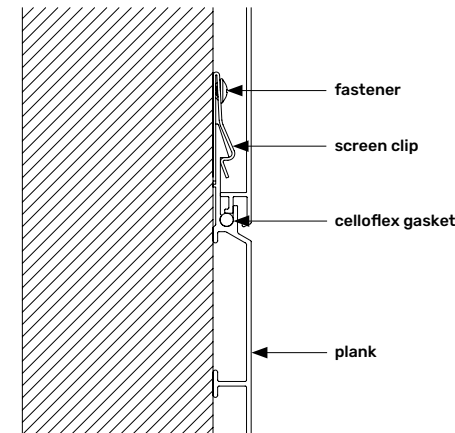

PHYSICAL DATA

6060/6063-T5 Extruded Aluminum
100% Recyclable
15 year warranty

WEIGHT

plank 4" [100mm] - 1.64 lb/sqft [8kg/m²]
plank 6" [150mm] - 1.64 lb/sqft [8kg/m²]
plank 8" [200mm] - 1.6 lb/sqft [7.8kg/m²]
plank 10" [250mm] - 1.47 lb/sqft [7.2kg/m²]

TESTING

Experimental verification of resistance performance to wind load under dynamic pressure and impact resistance (IRCCOS-TCLab section of Building Future Lab located in the Mediterranean University of Reggio Calabria)

Reaction to fire test (CS located in Senago (MI)).



Wind load
Up to 149.1 mph [240 km/h]



Resistance to soft body impact test
Reference standard:
EAD 090062-00-0404
Category I



Reaction to fire test
Reference standards:
EN 13823:2020
EN ISO 1716:2018
EN 13501-1:2019
A2-S2-d0

CLADDING

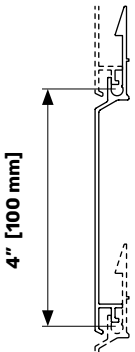
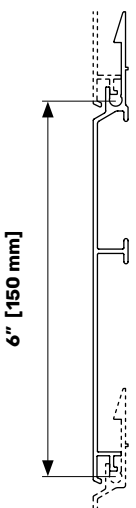
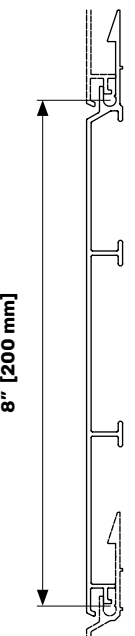
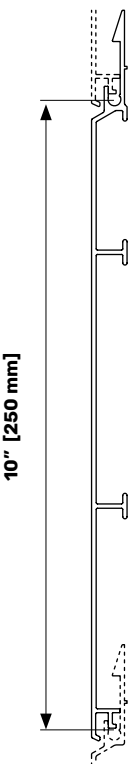
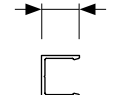
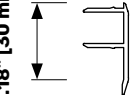
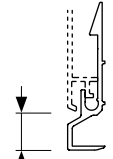
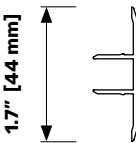
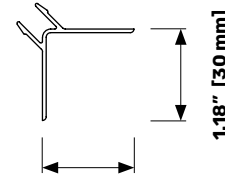
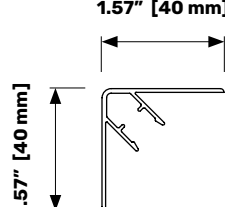
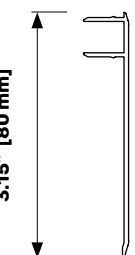
Planks				End profiles		
 <p>4" [100 mm]</p>	 <p>6" [150 mm]</p>	 <p>8" [200 mm]</p>	 <p>10" [250 mm]</p>	 <p>0.59" [15 mm]</p>		
CC00100 4" [100 mm] Plank	CC00150 6" [150 mm] Plank	CC00200 8" [200 mm] Plank	CC00250 10" [250 mm] Plank	CC00002 Trim base		
				 <p>1.18" [30 mm]</p>		
				CC00003 J-trim cover		
 <p>0.59" [15 mm]</p>	 <p>1.7" [44 mm]</p>		 <p>1.18" [30 mm]</p>		 <p>1.57" [40 mm]</p>	 <p>3.15" [80 mm]</p>
CC00001 Starter strip	CC00010 H-Trim cover	CC00011 Corner profile A	CC00012 Corner profile B	CC00007 Long J-Trim cover		

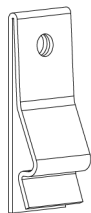

		Qty per bag
FA15001	Screen clip	100

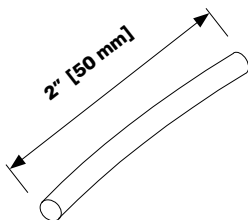

		Qty per bag
FA30005	Celloflex gasket	250