

**FOR  
ME**  
DESIGN

**SKIN**  
Indoor & Outdoor  
Aluminum Wall Cladding

**INSTALLATION GUIDE**

# **BATTENS LIGHT**



## **WALL AND SOFFIT INSTALLATION**



## BATTENS LIGHT

MINIMAL AND PRACTICAL  
ALUMINUM BATTEN CLADDING  
SYSTEM, SUITABLE FOR INDOOR.

The system includes a range of battens with depth of 0.98" (25 mm) and 2.95" (75 mm) and spacers of 0.79" (20 mm), 1.18" (30 mm) and 1.57" (40 mm) to create a ribbed effect with variable depth and width and cut-to-size spacers. **Corner profiles** give continuity to corner and curved walls, while **frame profiles** create light effects thanks to the **led holder**.

Battens are applied to the wall utilizing a substructure with nylon clips, that lock with rotation and then securing the battens with a precise and robust snap.

The locking system is mechanical. It allows quick installation and easy maintenance and/or replacement of the battens in case of damage.



### NON-COMBUSTIBLE

ForMe Skin is the ideal solution for cladding jobs requiring high fire performance as the products meet fire resistance requirements according to current legislation.



### QUICK AND EASY TO INSTALL

The installation of ForMe Skin is quick and intuitive. It requires no specialist skills. One single operator can apply the wall cladding system in a few simple steps. From the design choices to the decoration application to the type of substructure, the whole process is guided in every detail guaranteeing safety, easy installation and quick maintenance.



# Finishings ForMe's partner **DFV**

ForME, thanks to the great experience gained in the field of surface finishes of the parent company DFV s.r.l., is able to offer high quality products that ensure a long life. The DFV Group is a leader in Europe in the surface finishes of extruded aluminum profiles, it controls the entire supply chain, from extrusion to powder coating to decoration.

The only company to be able to offer in addition to the normal solid color finishes, 3 different types of wood-effect decoration on profiles and aluminum laminates, with a wide variety of finishes with very high resistance.

## Our decoration technologies include:



### HD PRINTING

Exclusive - High definition Digital technology that allows to replicate all types of finishes on aluminum profiles.



### POWDER ON POWDER COATED

Ezy - Wood-grain effect made with powder on powder technology developed entirely in DFV.



### SUBLIMATION COATED

Sublimall - Wood-grain effect made with sublimation technology.



### RAL COATED

Solid color finish.

## FULL QUALITY, SAFE ENVIRONMENT, GUARANTEED SAFETY

UNI EN ISO 9001:2015  
UNI EN ISO 14001:2015  
UNI ISO 45001:2018  
QUALICOAT  
QUALICOAT SEASIDE  
QUALICOAT QUALIDECO  
AAMA 2604  
AAMA 2605

## COMPANY WITH QAS MANAGEMENT SYSTEM CERTIFIED BY IWA CERMET ITALIA

ISO 9001:2015 - Reg. No 9443 - A  
ISO 14001:2015 - Reg. No 9443 - E  
ISO 45001:2018 - Reg. No 9443 - I



### CLASSE 2

Lic. n° 761 - Surano  
Lic. n° 780 - Agrigento  
Lic. n° 763 - Meolo



### CLASSE 2

Lic. n° IT-0012 - Surano  
Lic. n° IT-0022 - Agrigento  
Lic. n° IT-0014 - Meolo



## Warranty







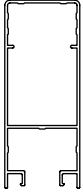

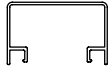
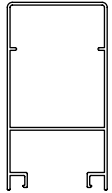
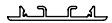
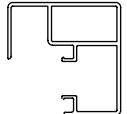
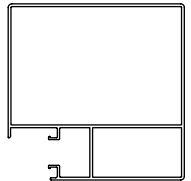



DFV finishes are made with respect for the environment and mainly use dry paints without the use of solvents or other volatile substances. Great attention is also paid to the preparation of surfaces and pre-treatment, that ensure high performance with the use of Chrome-free chemicals.

# Profile legend

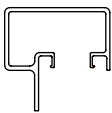
## Profiles

CODE		DESCRIPTION	LENGTH	QUANTITY PER BUNDLE
Battens	BA30026	 <b>1.18" x 0.98" Batten</b> <b>(30 mm x 25 mm Batten)</b>	16'9" (net 16'6") 5100 mm (net 5020 mm)  21'4" (net 21'1") 6500 mm (net 6420 mm)	20 pcs
	BA30032	 <b>1.18" x 2.95" Batten</b> <b>(30 mm x 75 mm Batten)</b>	16'9" (net 16'6") 5100 mm (net 5020 mm)  21'4" (net 21'1") 6500 mm (net 6420 mm)	12 pcs
	BA30021	 <b>1.18" Cover</b> <b>(30 mm Cover)</b>	16'9" (net 16'6") 5100 mm (net 5020 mm)  21'4" (net 21'1") 6500 mm (net 6420 mm)	42 pcs
	BA40001	 <b>1.57" x 0.98" Batten</b> <b>(40 mm x 25 mm Batten)</b>	16'9" (net 16'6") 5100 mm (net 5020 mm)  21'4" (net 21'1") 6500 mm (net 6420 mm)	32/16 pcs
	BA40002	 <b>1.57" x 2.95" Batten</b> <b>(40 mm x 75 mm Batten)</b>	16'9" (net 16'6") 5100 mm (net 5020 mm)  21'4" (net 21'1") 6500 mm (net 6420 mm)	8 pcs
	BA40003	 <b>2.95" Cover</b> <b>(40 mm Cover)</b>	16'9" (net 16'6") 5100 mm (net 5020 mm)  21'4" (net 21'1") 6500 mm (net 6420 mm)	33 pcs
Corner battens	BA30027	 <b>0.98" Corner batten</b> <b>(25 mm Corner batten)</b>	16'9" (net 16'6") 5100 mm (net 5020 mm)  21'4" (net 21'1") 6500 mm (net 6420 mm)	8 pcs
	BA30028	 <b>2.95" Corner batten</b> <b>(75 mm Corner batten)</b>	16'9" (net 16'6") 5100 mm (net 5020 mm)  21'4" (net 21'1") 6500 mm (net 6420 mm)	3/2 pcs

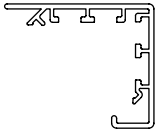
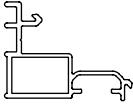
	CODE		DESCRIPTION	LENGTH	QUANTITY PER BUNDLE
Fixing bars	BA30002		<b>Fixing bar</b>	21'4" (net 21'1") 6500 mm (net 6420 mm)	44 pcs
	BA30020		<b>Suspended ceilings fixing bar</b>	21'4" (net 21'1") 6500 mm (net 6420 mm)	18 pcs
	BA30019		<b>Fixing bar cover</b>	21'4" (net 21'1") 6500 mm (net 6420 mm)	48 pcs
Spacers	BA30001		<b>0.79" Spacer (20 mm Spacer)</b>	16'9" (net 16'6") 5100 mm (net 5020 mm) 21'4" (net 21'1") 6500 mm (net 6420 mm)	56 pcs
	BA30017		<b>1.18" Spacer (30 mm Spacer)</b>	16'9" (net 16'6") 5100 mm (net 5020 mm) 21'4" (net 21'1") 6500 mm (net 6420 mm)	42 pcs
	BA30018		<b>1.57" Spacer (40 mm Spacer)</b>	16'9" (net 16'6") 5100 mm (net 5020 mm) 21'4" (net 21'1") 6500 mm (net 6420 mm)	36 pcs
	BA30033		<b>Cut-to-size spacer</b>	21'4" (net 21'1") 6500 mm (net 6420 mm)	22 pcs
Finishing profiles	BA30024		<b>End batten</b>	16'9" (net 16'6") 5100 mm (net 5020 mm) 21'4" (net 21'1") 6500 mm (net 6420 mm)	7 pcs
	BA30025		<b>End cut-to-size spacer</b>	16'9" (net 16'6") 5100 mm (net 5020 mm) 21'4" (net 21'1") 6500 mm (net 6420 mm)	20 pcs

CODE		DESCRIPTION	LENGTH	QUANTITY PER BUNDLE
BA30007		<b>Frame for 0.98" batten</b>	21'4" (net 21'1") 6500 mm (net 6420 mm)	6 pcs
BA30008		<b>Led holder for 0.98" batten</b>	21'4" (net 21'1") 6500 mm (net 6420 mm)	6 pcs
BA30023		<b>Led holder profile</b>	21'4" (net 21'1") 6500 mm (net 6420 mm)	16 pcs

Led holder profiles

# Screws

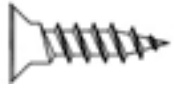

**Wood**

Stainless steel wood screw #10 with countersunk head

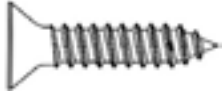



**Metal furring**

Stainless steel self-tapping screw #10 with countersunk head

# Tools legend

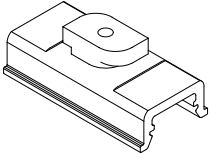
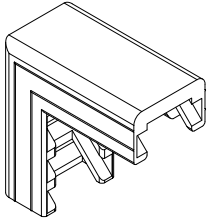
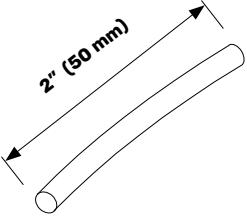
## Clips and Connectors

	<table border="1"> <thead> <tr> <th colspan="2"></th> <th style="text-align: right;">Qty per bag</th> </tr> </thead> <tbody> <tr> <td>FA30001</td> <td><b>1.18" batten nylon clip</b></td> <td style="text-align: right;">100</td> </tr> </tbody> </table>			Qty per bag	FA30001	<b>1.18" batten nylon clip</b>	100
		Qty per bag					
FA30001	<b>1.18" batten nylon clip</b>	100					
	<table border="1"> <thead> <tr> <th colspan="2"></th> <th style="text-align: right;">Qty per bag</th> </tr> </thead> <tbody> <tr> <td>FA30004</td> <td><b>1.18" plastic corner joint</b></td> <td style="text-align: right;">50</td> </tr> </tbody> </table>			Qty per bag	FA30004	<b>1.18" plastic corner joint</b>	50
		Qty per bag					
FA30004	<b>1.18" plastic corner joint</b>	50					
	<table border="1"> <thead> <tr> <th colspan="2"></th> <th style="text-align: right;">Qty per bag</th> </tr> </thead> <tbody> <tr> <td>FA30005</td> <td><b>celloflex gasket</b></td> <td style="text-align: right;">250</td> </tr> </tbody> </table>			Qty per bag	FA30005	<b>celloflex gasket</b>	250
		Qty per bag					
FA30005	<b>celloflex gasket</b>	250					
	<table border="1"> <thead> <tr> <th colspan="2"></th> <th style="text-align: right;">Qty per bag</th> </tr> </thead> <tbody> <tr> <td>FA30006</td> <td><b>corner joint for open profiles</b></td> <td style="text-align: right;">250</td> </tr> </tbody> </table>			Qty per bag	FA30006	<b>corner joint for open profiles</b>	250
		Qty per bag					
FA30006	<b>corner joint for open profiles</b>	250					
	<table border="1"> <thead> <tr> <th colspan="2"></th> <th style="text-align: right;">Qty per bag</th> </tr> </thead> <tbody> <tr> <td>FA30007</td> <td><b>corner joint with outward buttons</b></td> <td style="text-align: right;">250</td> </tr> </tbody> </table>			Qty per bag	FA30007	<b>corner joint with outward buttons</b>	250
		Qty per bag					
FA30007	<b>corner joint with outward buttons</b>	250					

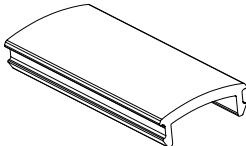
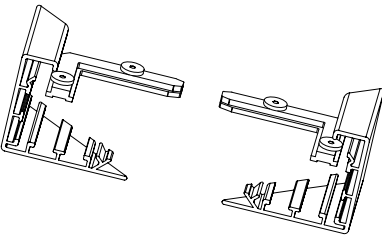
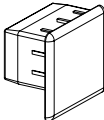
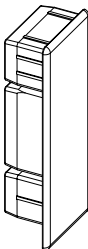
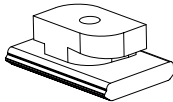

# Tools legend

## Clips and Connectors

	<table border="1"> <thead> <tr> <th colspan="2"></th> <th style="text-align: right;">Qty per bag</th> </tr> </thead> <tbody> <tr> <td>FA30008</td> <td><b>screen profile in polycarbonate L=9.84' (3000 mm)</b></td> <td style="text-align: right;">1</td> </tr> </tbody> </table>			Qty per bag	FA30008	<b>screen profile in polycarbonate L=9.84' (3000 mm)</b>	1																		
		Qty per bag																							
FA30008	<b>screen profile in polycarbonate L=9.84' (3000 mm)</b>	1																							
	<table border="1"> <thead> <tr> <th colspan="2"></th> <th style="text-align: right;">Qty per bag</th> </tr> </thead> <tbody> <tr> <td>FA30009</td> <td><b>right and left frame profile cap</b></td> <td style="text-align: right;">1</td> </tr> </tbody> </table>			Qty per bag	FA30009	<b>right and left frame profile cap</b>	1																		
		Qty per bag																							
FA30009	<b>right and left frame profile cap</b>	1																							
	<table border="1"> <thead> <tr> <th colspan="2"></th> <th style="text-align: right;">Qty per bag</th> </tr> </thead> <tbody> <tr> <td>FA30010_1013</td> <td><b>1.18" x 0.98" batten cap, RAL 1013</b></td> <td style="text-align: right;">50</td> </tr> <tr> <td>FA30010_7001</td> <td><b>1.18" x 0.98" batten cap, RAL 7001</b></td> <td style="text-align: right;">50</td> </tr> <tr> <td>FA30010_8017</td> <td><b>1.18" x 0.98" batten cap, RAL 8017</b></td> <td style="text-align: right;">50</td> </tr> <tr> <td>FA30010_8023</td> <td><b>1.18" x 0.98" batten cap, RAL 8023</b></td> <td style="text-align: right;">50</td> </tr> <tr> <td>FA30010_9005</td> <td><b>1.18" x 0.98" batten cap, RAL 9005</b></td> <td style="text-align: right;">50</td> </tr> <tr> <td>FA30010_9010</td> <td><b>1.18" x 0.98" batten cap, RAL 9010</b></td> <td style="text-align: right;">50</td> </tr> <tr> <td>FA30010_EXC</td> <td><b>1.18" x 0.98" batten cap, Exclusive digital printed wood-grain decoration</b></td> <td style="text-align: right;">50</td> </tr> </tbody> </table>			Qty per bag	FA30010_1013	<b>1.18" x 0.98" batten cap, RAL 1013</b>	50	FA30010_7001	<b>1.18" x 0.98" batten cap, RAL 7001</b>	50	FA30010_8017	<b>1.18" x 0.98" batten cap, RAL 8017</b>	50	FA30010_8023	<b>1.18" x 0.98" batten cap, RAL 8023</b>	50	FA30010_9005	<b>1.18" x 0.98" batten cap, RAL 9005</b>	50	FA30010_9010	<b>1.18" x 0.98" batten cap, RAL 9010</b>	50	FA30010_EXC	<b>1.18" x 0.98" batten cap, Exclusive digital printed wood-grain decoration</b>	50
		Qty per bag																							
FA30010_1013	<b>1.18" x 0.98" batten cap, RAL 1013</b>	50																							
FA30010_7001	<b>1.18" x 0.98" batten cap, RAL 7001</b>	50																							
FA30010_8017	<b>1.18" x 0.98" batten cap, RAL 8017</b>	50																							
FA30010_8023	<b>1.18" x 0.98" batten cap, RAL 8023</b>	50																							
FA30010_9005	<b>1.18" x 0.98" batten cap, RAL 9005</b>	50																							
FA30010_9010	<b>1.18" x 0.98" batten cap, RAL 9010</b>	50																							
FA30010_EXC	<b>1.18" x 0.98" batten cap, Exclusive digital printed wood-grain decoration</b>	50																							
	<table border="1"> <thead> <tr> <th colspan="2"></th> <th style="text-align: right;">Qty per bag</th> </tr> </thead> <tbody> <tr> <td>FA30011_1013</td> <td><b>1.18" x 2.95" batten cap, RAL 1013</b></td> <td style="text-align: right;">50</td> </tr> <tr> <td>FA30011_7001</td> <td><b>1.18" x 2.95" batten cap, RAL 7001</b></td> <td style="text-align: right;">50</td> </tr> <tr> <td>FA30011_8017</td> <td><b>1.18" x 2.95" batten cap, RAL 8017</b></td> <td style="text-align: right;">50</td> </tr> <tr> <td>FA30011_8023</td> <td><b>1.18" x 2.95" batten cap, RAL 8023</b></td> <td style="text-align: right;">50</td> </tr> <tr> <td>FA30011_9005</td> <td><b>1.18" x 2.95" batten cap, RAL 9005</b></td> <td style="text-align: right;">50</td> </tr> <tr> <td>FA30011_9010</td> <td><b>1.18" x 2.95" batten cap, RAL 9010</b></td> <td style="text-align: right;">50</td> </tr> <tr> <td>FA30011_EXC</td> <td><b>1.18" x 2.95" batten cap, Exclusive digital printed wood-grain decoration</b></td> <td style="text-align: right;">50</td> </tr> </tbody> </table>			Qty per bag	FA30011_1013	<b>1.18" x 2.95" batten cap, RAL 1013</b>	50	FA30011_7001	<b>1.18" x 2.95" batten cap, RAL 7001</b>	50	FA30011_8017	<b>1.18" x 2.95" batten cap, RAL 8017</b>	50	FA30011_8023	<b>1.18" x 2.95" batten cap, RAL 8023</b>	50	FA30011_9005	<b>1.18" x 2.95" batten cap, RAL 9005</b>	50	FA30011_9010	<b>1.18" x 2.95" batten cap, RAL 9010</b>	50	FA30011_EXC	<b>1.18" x 2.95" batten cap, Exclusive digital printed wood-grain decoration</b>	50
		Qty per bag																							
FA30011_1013	<b>1.18" x 2.95" batten cap, RAL 1013</b>	50																							
FA30011_7001	<b>1.18" x 2.95" batten cap, RAL 7001</b>	50																							
FA30011_8017	<b>1.18" x 2.95" batten cap, RAL 8017</b>	50																							
FA30011_8023	<b>1.18" x 2.95" batten cap, RAL 8023</b>	50																							
FA30011_9005	<b>1.18" x 2.95" batten cap, RAL 9005</b>	50																							
FA30011_9010	<b>1.18" x 2.95" batten cap, RAL 9010</b>	50																							
FA30011_EXC	<b>1.18" x 2.95" batten cap, Exclusive digital printed wood-grain decoration</b>	50																							
	<table border="1"> <thead> <tr> <th colspan="2"></th> <th style="text-align: right;">Qty per bag</th> </tr> </thead> <tbody> <tr> <td>FA30013</td> <td><b>complementary profiles clip</b></td> <td style="text-align: right;">100</td> </tr> </tbody> </table>			Qty per bag	FA30013	<b>complementary profiles clip</b>	100																		
		Qty per bag																							
FA30013	<b>complementary profiles clip</b>	100																							

# Tools legend

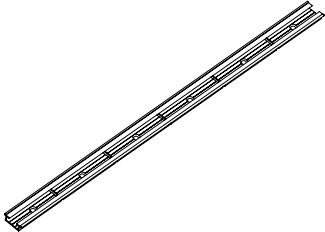
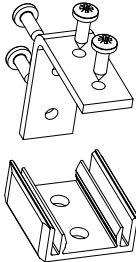
## Clips and Connectors

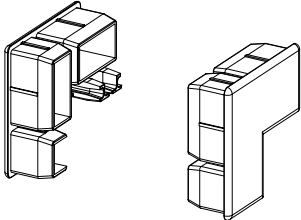
	<table border="1"> <thead> <tr> <th colspan="2"></th> <th style="text-align: right;">Qty per bag</th> </tr> </thead> <tbody> <tr> <td>FA30015</td> <td><b>support profile for curved surfaces L=3.28' (1000 mm)</b></td> <td style="text-align: right;">1</td> </tr> </tbody> </table>			Qty per bag	FA30015	<b>support profile for curved surfaces L=3.28' (1000 mm)</b>	1			
		Qty per bag								
FA30015	<b>support profile for curved surfaces L=3.28' (1000 mm)</b>	1								
	<table border="1"> <thead> <tr> <th colspan="2"></th> <th style="text-align: right;">Qty per bag</th> </tr> </thead> <tbody> <tr> <td>FA30016</td> <td><b>corner bracket kit for 1.57" x 2.95" batten</b></td> <td style="text-align: right;">25</td> </tr> </tbody> </table>			Qty per bag	FA30016	<b>corner bracket kit for 1.57" x 2.95" batten</b>	25			
		Qty per bag								
FA30016	<b>corner bracket kit for 1.57" x 2.95" batten</b>	25								
	<table border="1"> <thead> <tr> <th colspan="2"></th> <th style="text-align: right;">Qty per bag</th> </tr> </thead> <tbody> <tr> <td>FA30018</td> <td><b>hanging wire with spring for suspended ceilings</b></td> <td style="text-align: right;">1</td> </tr> </tbody> </table>			Qty per bag	FA30018	<b>hanging wire with spring for suspended ceilings</b>	1			
		Qty per bag								
FA30018	<b>hanging wire with spring for suspended ceilings</b>	1								
	<table border="1"> <thead> <tr> <th colspan="2"></th> <th style="text-align: right;">Qty per bag</th> </tr> </thead> <tbody> <tr> <td>FA30019</td> <td><b>hanging wire with open eyelet for suspended ceilings</b></td> <td style="text-align: right;">1</td> </tr> </tbody> </table>			Qty per bag	FA30019	<b>hanging wire with open eyelet for suspended ceilings</b>	1			
		Qty per bag								
FA30019	<b>hanging wire with open eyelet for suspended ceilings</b>	1								
	<table border="1"> <thead> <tr> <th colspan="2"></th> <th style="text-align: right;">Qty per bag</th> </tr> </thead> <tbody> <tr> <td>FA30022_9005</td> <td><b>0.98" corner batten cap, RAL 9005</b></td> <td style="text-align: right;">1</td> </tr> <tr> <td>FA30022/EXC</td> <td><b>0.98" corner batten cap, RAL Exclusive, Ezy and Sublimated decorations</b></td> <td style="text-align: right;">1</td> </tr> </tbody> </table>			Qty per bag	FA30022_9005	<b>0.98" corner batten cap, RAL 9005</b>	1	FA30022/EXC	<b>0.98" corner batten cap, RAL Exclusive, Ezy and Sublimated decorations</b>	1
		Qty per bag								
FA30022_9005	<b>0.98" corner batten cap, RAL 9005</b>	1								
FA30022/EXC	<b>0.98" corner batten cap, RAL Exclusive, Ezy and Sublimated decorations</b>	1								

# Tools legend

## Clips and Connectors

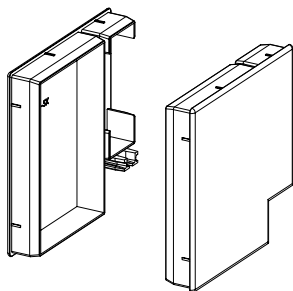

		Qty per bag
FA30023_9005	<b>2.95" corner batten cap, RAL 9005</b>	1
FA30023/EXC	<b>2.95" corner batten cap, RAL Exclusive, Ezy and Sublimated decorations</b>	1

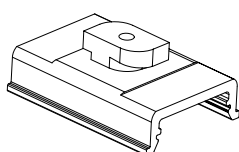

		Qty per bag
FA40001	<b>1.57" batten nylon clip</b>	100



		Qty per bag
FA40003_1013	<b>1.57" x 0.98" batten cap, RAL 1013</b>	50
FA40003_7001	<b>1.57" x 0.98" batten cap, RAL 7001</b>	50
FA40003_8017	<b>1.57" x 0.98" batten cap, RAL 8017</b>	50
FA40003_8023	<b>1.57" x 0.98" batten cap, RAL 8023</b>	50
FA40003_9005	<b>1.57" x 0.98" batten cap, RAL 9005</b>	50
FA40003_9010	<b>1.57" x 0.98" batten cap, RAL 9010</b>	50
FA40003_EXC	<b>1.57" x 0.98" batten cap, Exclusive digital printed wood-grain decoration</b>	50

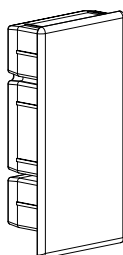

		Qty per bag
FA40004_1013	<b>1.18" x 2.95" batten cap, RAL 1013</b>	50
FA40004_7001	<b>1.18" x 2.95" batten cap, RAL 7001</b>	50
FA40004_8017	<b>1.18" x 2.95" batten cap, RAL 8017</b>	50
FA40004_8023	<b>1.18" x 2.95" batten cap, RAL 8023</b>	50
FA40004_9005	<b>1.18" x 2.95" batten cap, RAL 9005</b>	50
FA40004_9010	<b>1.18" x 2.95" batten cap, RAL 9010</b>	50
FA40004_EXC	<b>1.18" x 2.95" batten cap, Exclusive digital printed wood-grain decoration</b>	50

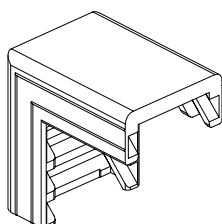

		Qty per bag
FA40005	<b>1.57" plastic corner joint</b>	50

# Tools legend

## Clips and Connectors

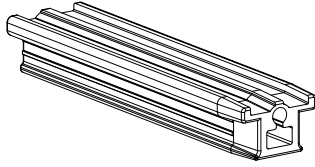

		Qty per bag
FA30021	<b>safety device for 1.18" batten</b>	50

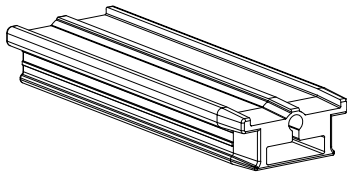

		Qty per bag
FA40006	<b>safety device for 1.57" batten</b>	50

# Before starting to work

- ☛ Ensure that the product is stored in a protected and dry environment, in order to protect the cardboard box and its label.
- ☛ Carefully handle packages containing SKIN products.
- ☛ Follow the specifications for the correct installation of the product.
- ☛ Wear appropriate safety equipment to ensure that the working environment is safe.
- ☛ Make sure you have all the correct equipment.

---

## WARNINGS

- ☛ Install cladding and components in accordance with manufacturer's written installation guide and design drawings.
- ☛ Install all profiles using stainless steel in accordance with the manufacturer's written instructions.  
All fasteners should penetrate into solid, secure framing or blocking.
- ☛ Install screw fasteners using power tools having controlled torque.
- ☛ Do not install damaged profiles; repair or replace as required.

## STORAGE AND HANDLING

- ☛ The product can be stored outdoors, the aluminum will not be damaged by humidity and temperature change.
- ☛ The cardboard box may be damaged if exposed to the weather, as well as the label that highlights the content.
- ☛ Do not stack other material on pallets.
- ☛ To prevent damage to the material, do not bump and scrape against walls, floor or any other surface.

# Low-maintenance



For a longer life it is recommended to wash the surfaces with plenty of water and mild soap, using soft brushes so as not to damage the finish.

---

## During cleaning, you should definitely pay attention to the following aspects:

1. do not use acidic or alkaline detergents;
2. do not use abrasive products and/or materials;
3. do not use organic solvents (on powder coated surfaces);
4. do not use detergents of unknown chemical composition;
5. do not apply the products directly to the surfaces to be cleaned;
6. the surfaces during cleaning must be “cold” (Tmax=86°F) and not directly exposed to the sun;
7. detergents used for cleaning shall also be “cold” (Tmax=86°F) and vapour spray equipment shall not be used.



# Specifications of the pallet

Material will be received on a pallet.

## **PALLET SIZE**

maximum length: 16'6" (5030 mm)

maximum width: 29.3" (745 mm)

maximum height: 30.1" (766 mm)









Check the labels and make sure you have all the required components in your order

All profiles are wrapped in protective paper and labelled indicating number of pieces and product type.













# Protection equipment

We recommend the appropriate use and application of the following tools during installation.

<b>1</b> 	<b>2</b> 	<b>3</b> 
Steel toe boots	Cut resistant gloves	Safety glasses
<b>4</b> 	<b>5</b> 	<b>6</b> 
Hard hat	Ear protection	Safety vest
<b>7</b> 	<b>8</b> 	
Fall protection	First aid	

# Tools and accessories

The following general tool will also be required for installation.

<p><b>1</b></p> 	<p><b>2</b></p> 	<p><b>3</b></p> 	
<p><b>Worktables</b></p>	<p><b>Miter saw with carbide blade non-ferrous 40-120 teeth</b></p>	<p><b>Power cord</b></p>	
<p><b>4</b></p> 	<p><b>5</b></p> 	<p><b>6</b></p> 	
<p><b>Drill</b></p>	<p><b>Drill bit set</b></p>	<p><b>Level</b></p>	
<p><b>7</b></p> 	<p><b>8</b></p> 	<p><b>9</b></p> 	<p><b>10</b></p> 
<p><b>Hammer</b></p>	<p><b>Rubber hammer</b></p>	<p><b>Tape measure</b></p>	<p><b>Laser level</b></p>

# INSTALLATION STEPS

# **STEP 1** **START**

## **Wall preparation**

Follow the local building codes.

Before starting the installation of the battens identify the substrate material:

- direct to wood or MgO substrate;
- wood furring, or framing;
- metal furring, or framing.

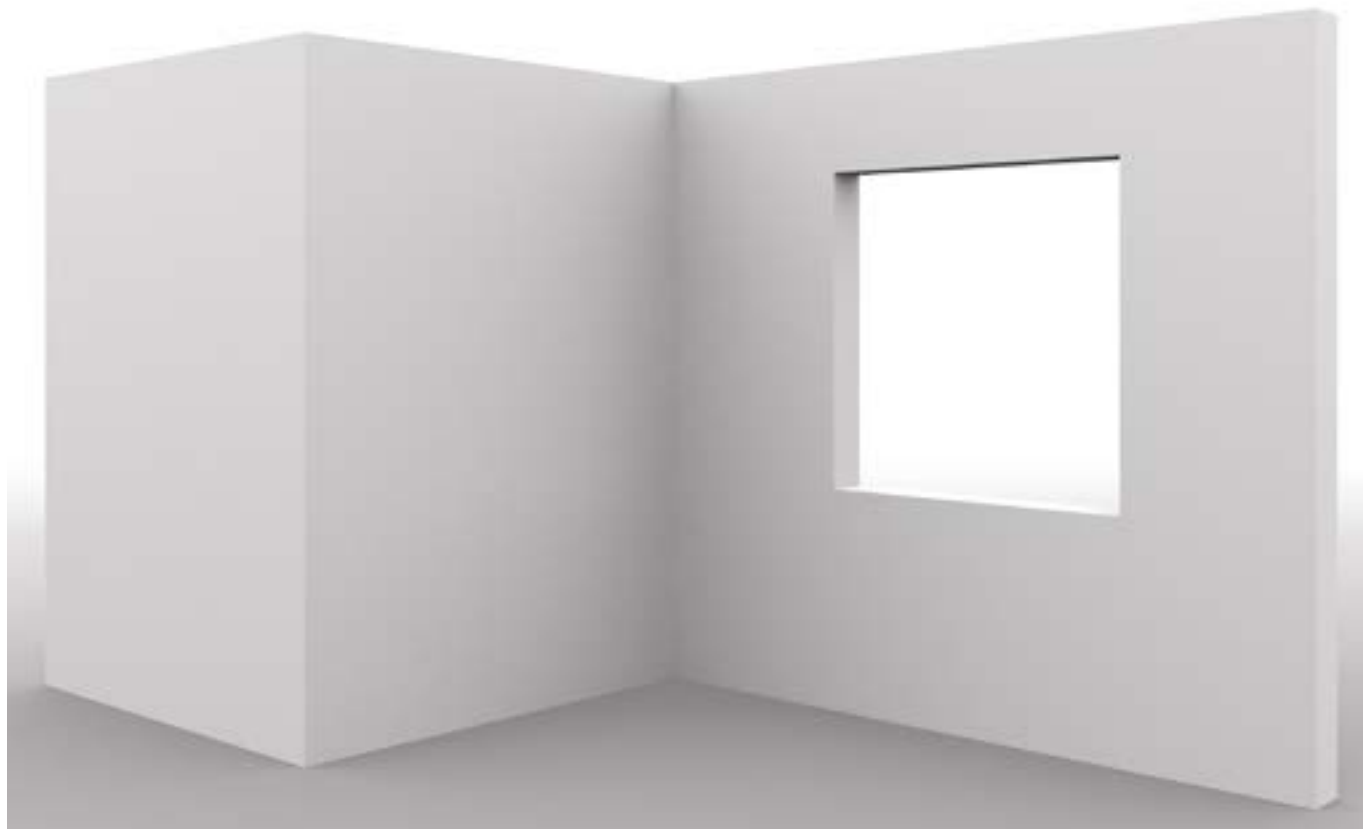

# STEP 2

Make countersunk holes on the fixing bar at a recommended distance of 2' ( $\approx$  600 mm).

The countersunk hole must accommodate the head of the screw in such a way that it does not obstruct the inclusion of the clip into the fixing bar.

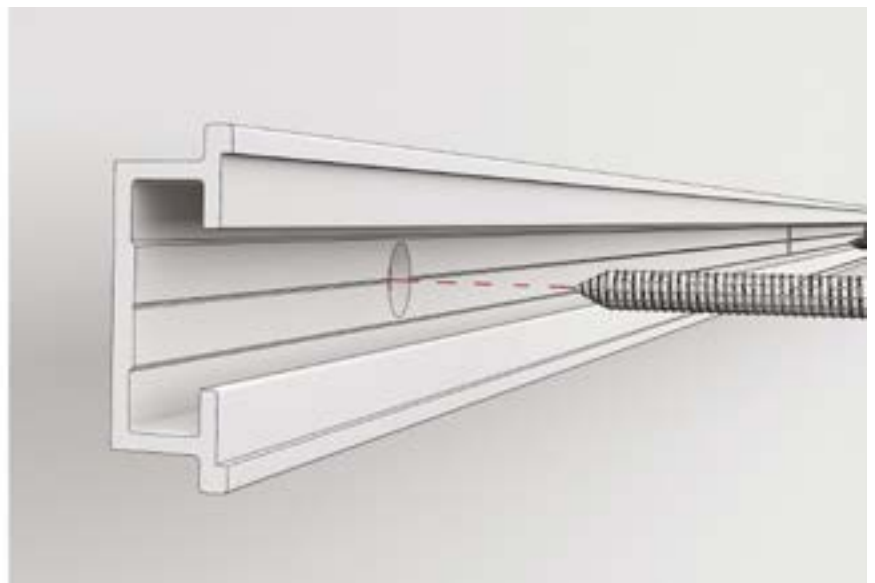
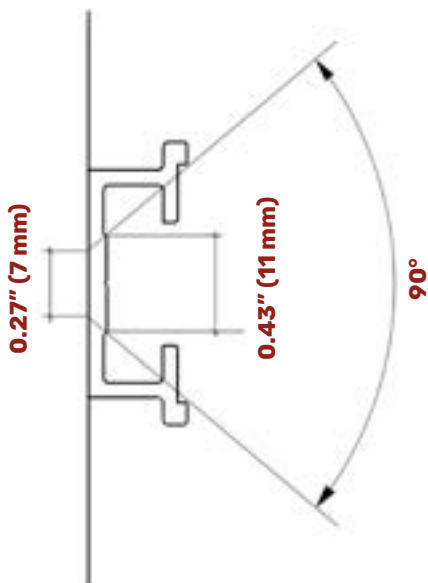

Fix the bars with the appropriate screws. The first and last fixing bars are placed at a distance of 4" ( $\approx$  100 mm) from the floor/ceiling.

The maximum recommended distance between fixing bars is 2.5' ( $\approx$  750 mm): the exact value depends on the measurements taken on site.



## STEP 2

Near the outer corner one fixing bar must protrude approximately 3/4" ( $\approx 19$  mm) from the wall.

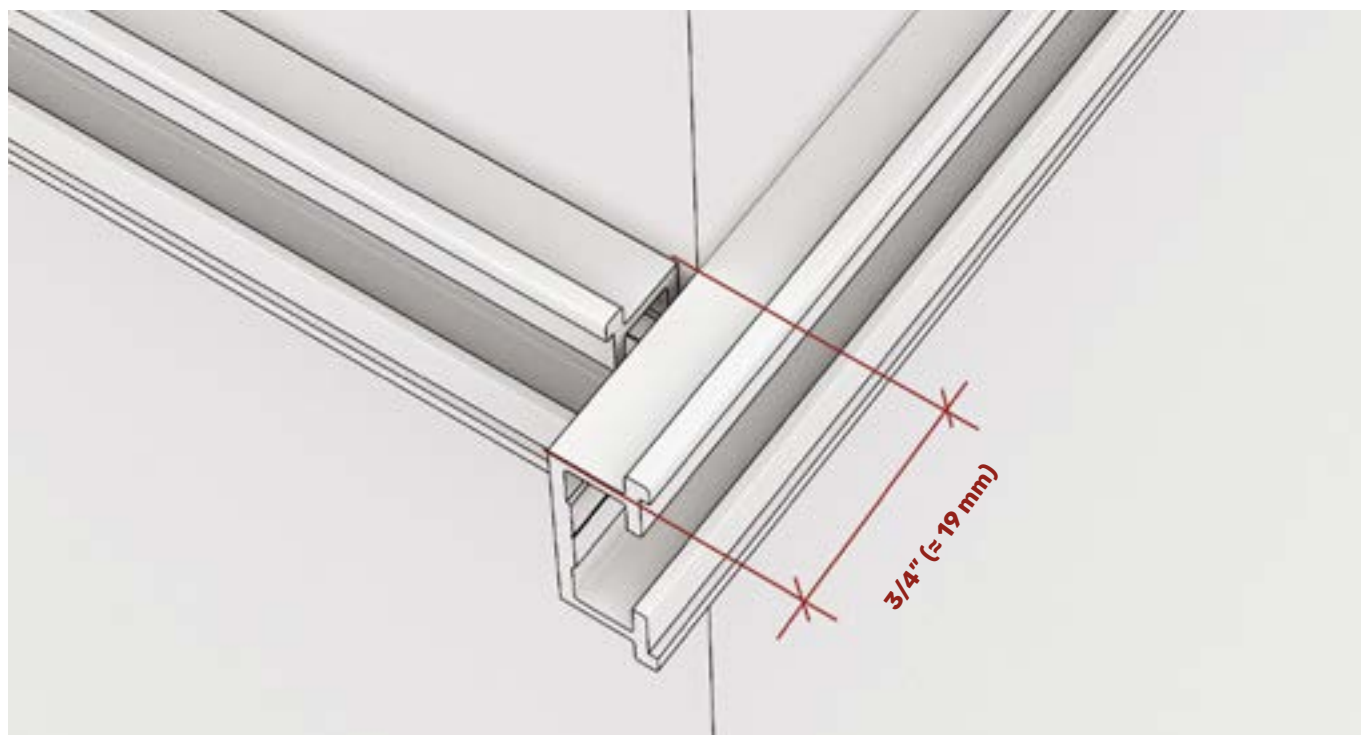
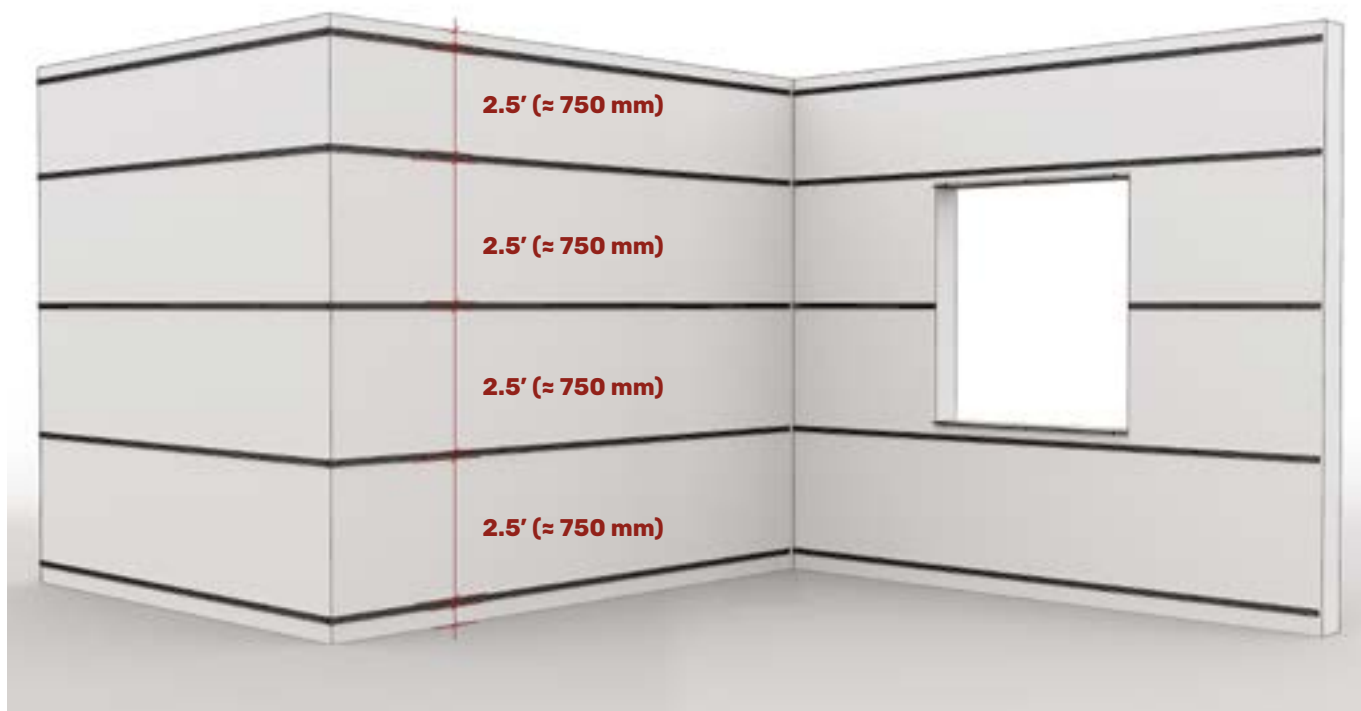

## STEP 2

Fix a L-profile (whose size depends on the height of the batten) above and below the window.

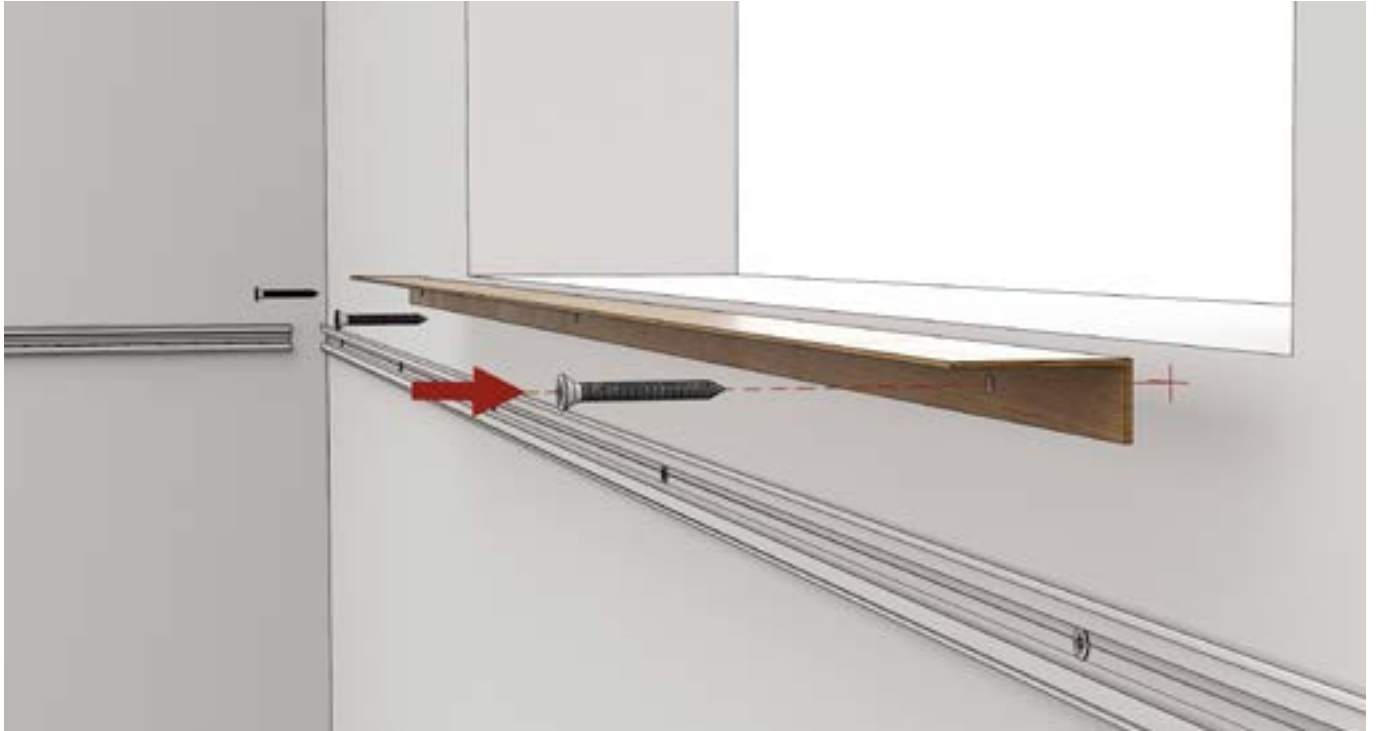

# STEP 2

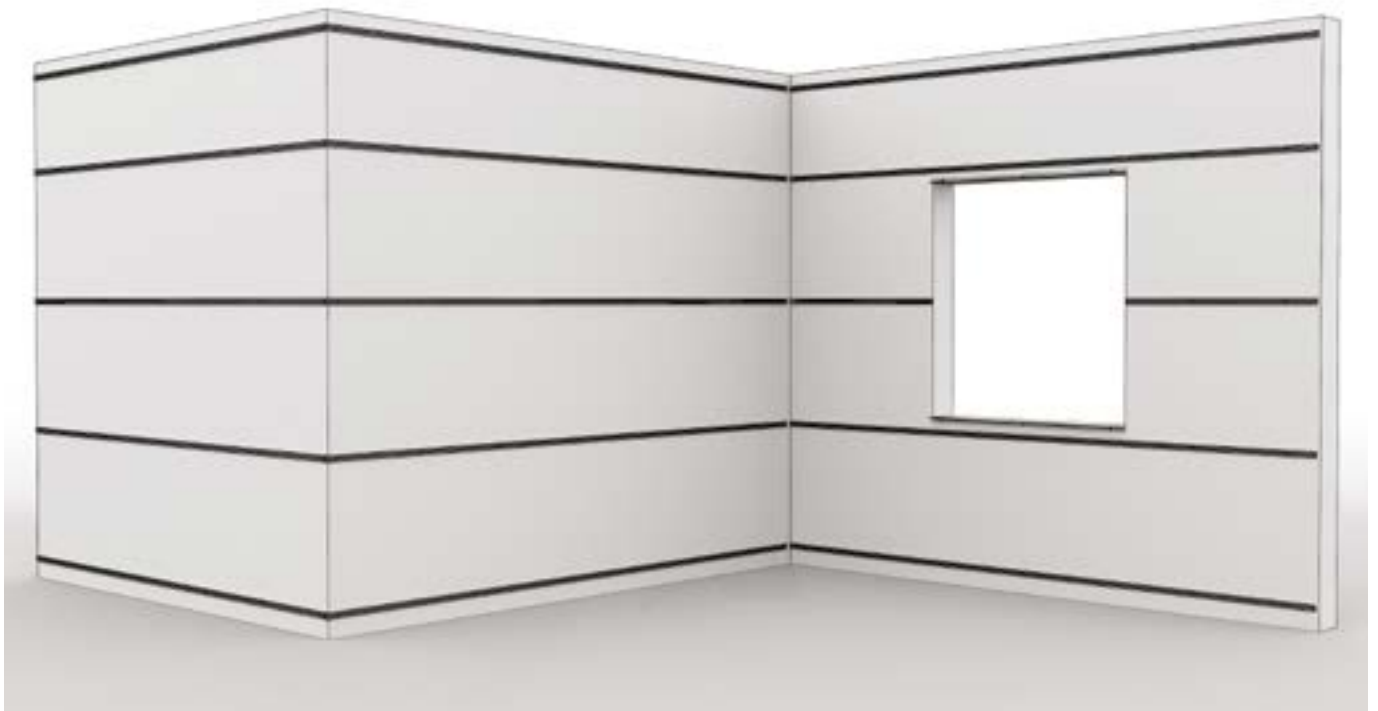

## STEP 3

Place the clip for complementary profiles into the fixing bar near the outer corner.



Rotate the clip by 90° with the metric hexagonal key (size 6 mm) in order to lock it into the fixing bar.



## STEP 3

Cut-to-size the end spacer then snap it on the clip for complementary profiles.  
If the end cut-to-size spacer is used, a gap of 0.12" (3 mm) between the fixing bar and the wall has to be guaranteed.



# STEP 3

Place the clip into the fixing bar.

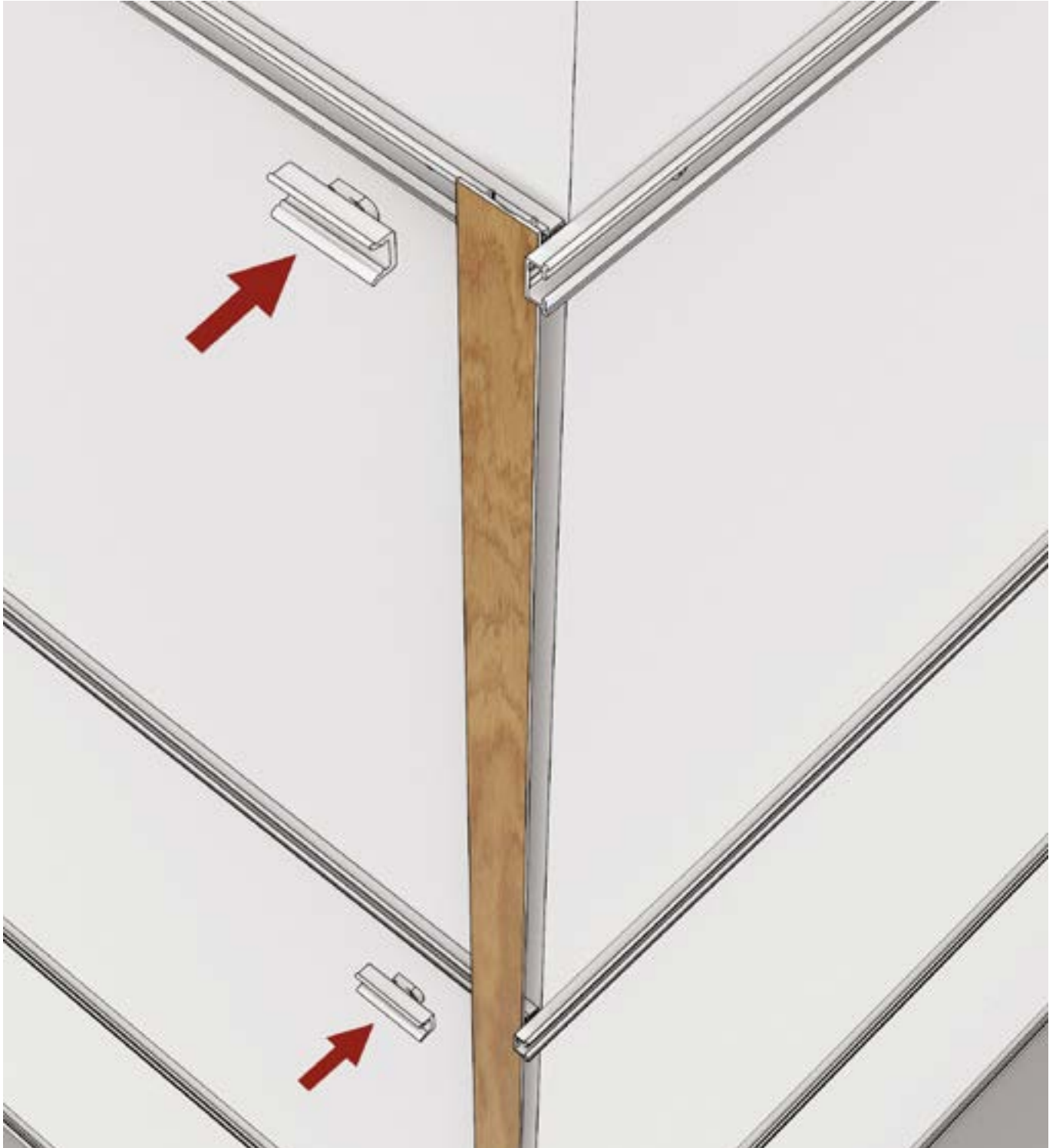

# STEP 3

Rotate the clip by 90° in order to lock it.



# STEP 3

Move the clip until it is adjacent to the spacer.



# STEP 3

Insert the pieces of gasket into the slots of the spacer in correspondence of the fixing bars.



# STEP 3

Place the spacer putting it adjacent to the clip.



# STEP 3

Place the other clip and move it until it contacts the spacer.

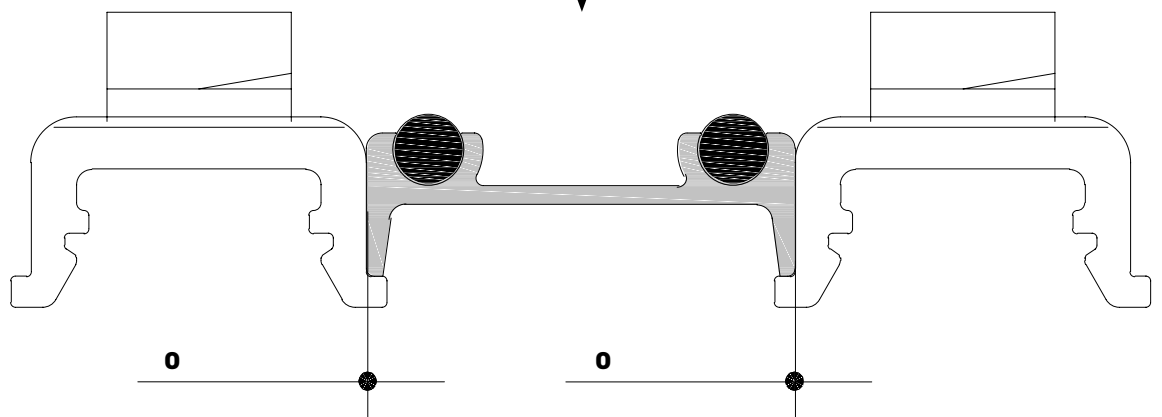

# STEP 3

Place all the spacers on the first wall.

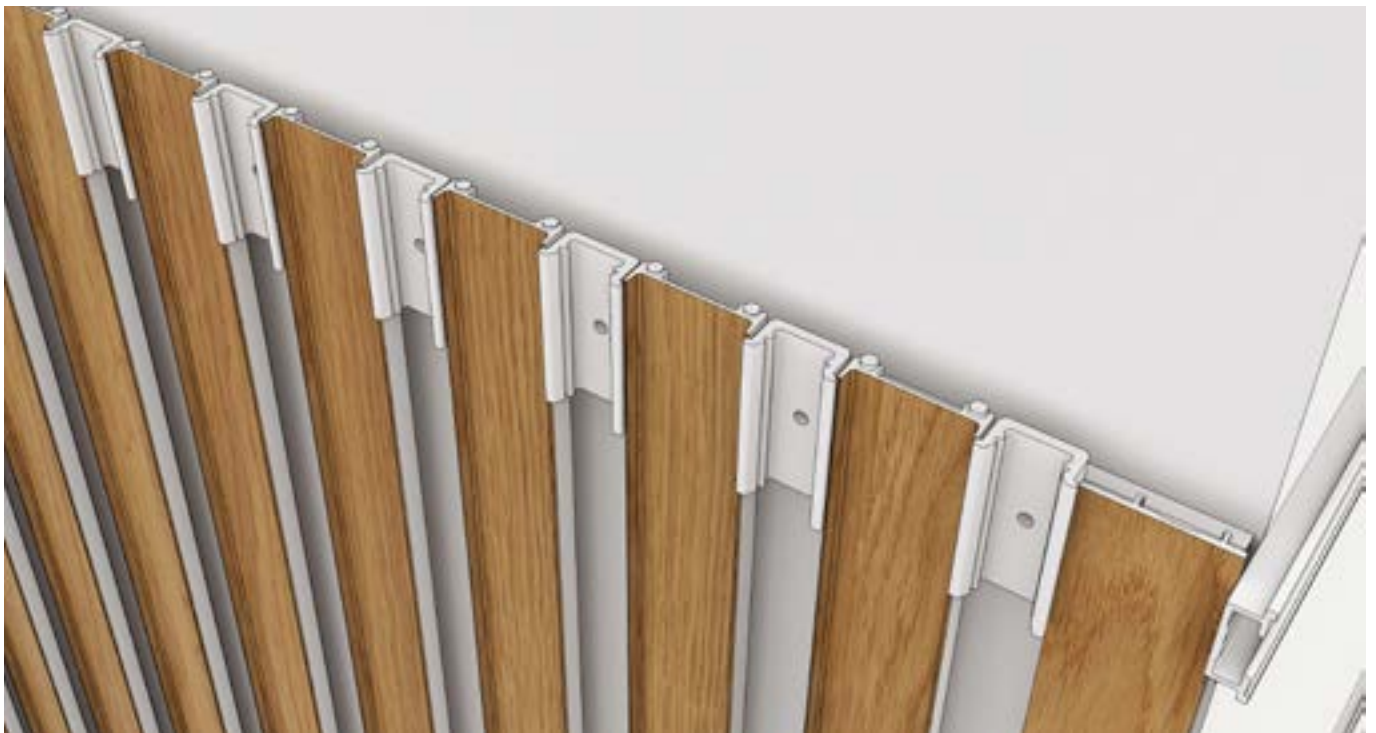

# STEP 3

Snap all the battens, except the last one, on the clips.



## STEP 3

If the wall cladding ends with a spacer use the end cut-to-size spacer.  
Place the clip for complementary profiles and snap the end cut-to-size spacer.

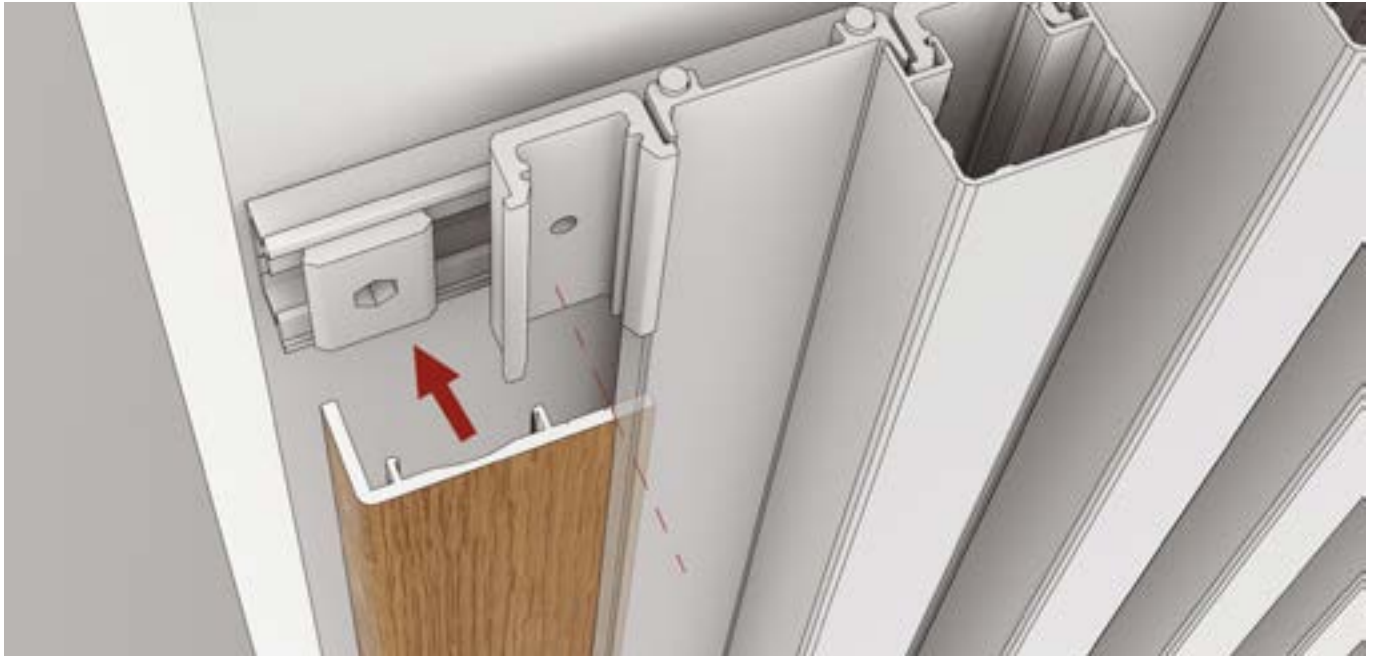

Snap the last battens on the clip.



## STEP 3

If the wall cladding ends with the batten, use an angular profile for the lateral finishing.  
Get the L-profile closer to the fixing bar in order to detect the position of the notchings to make.

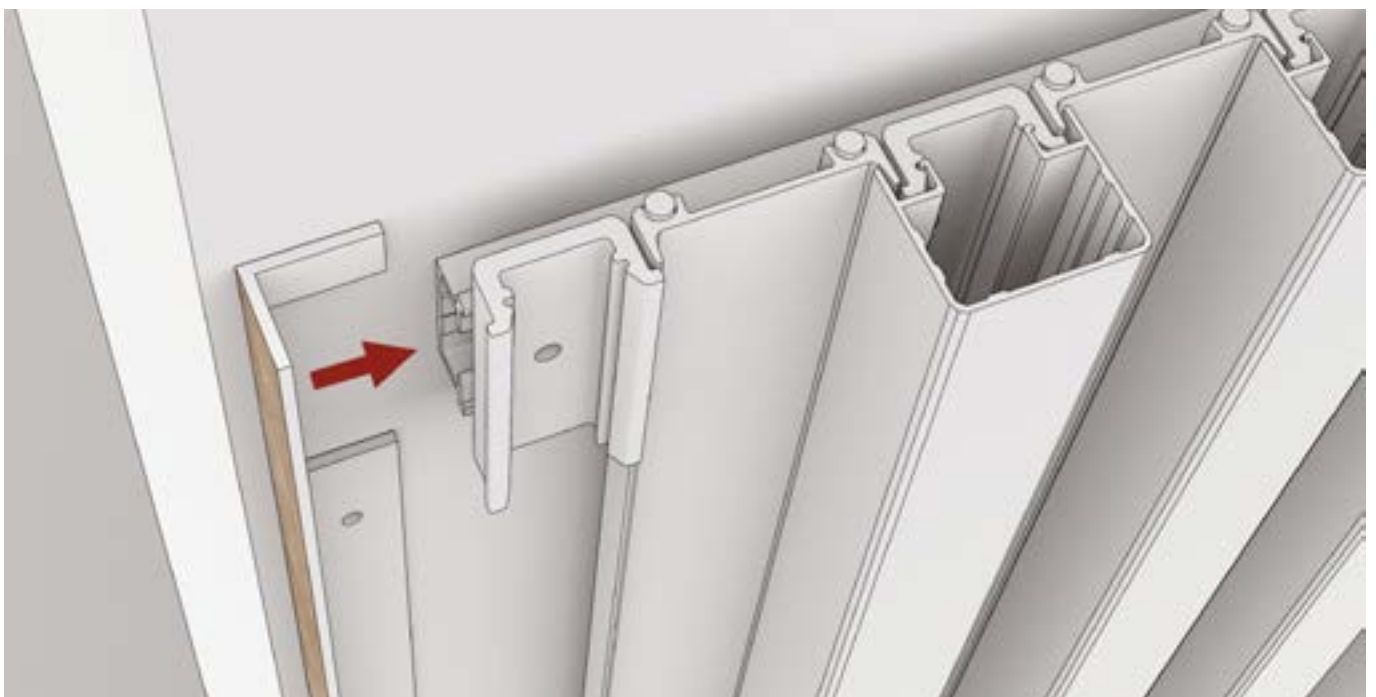
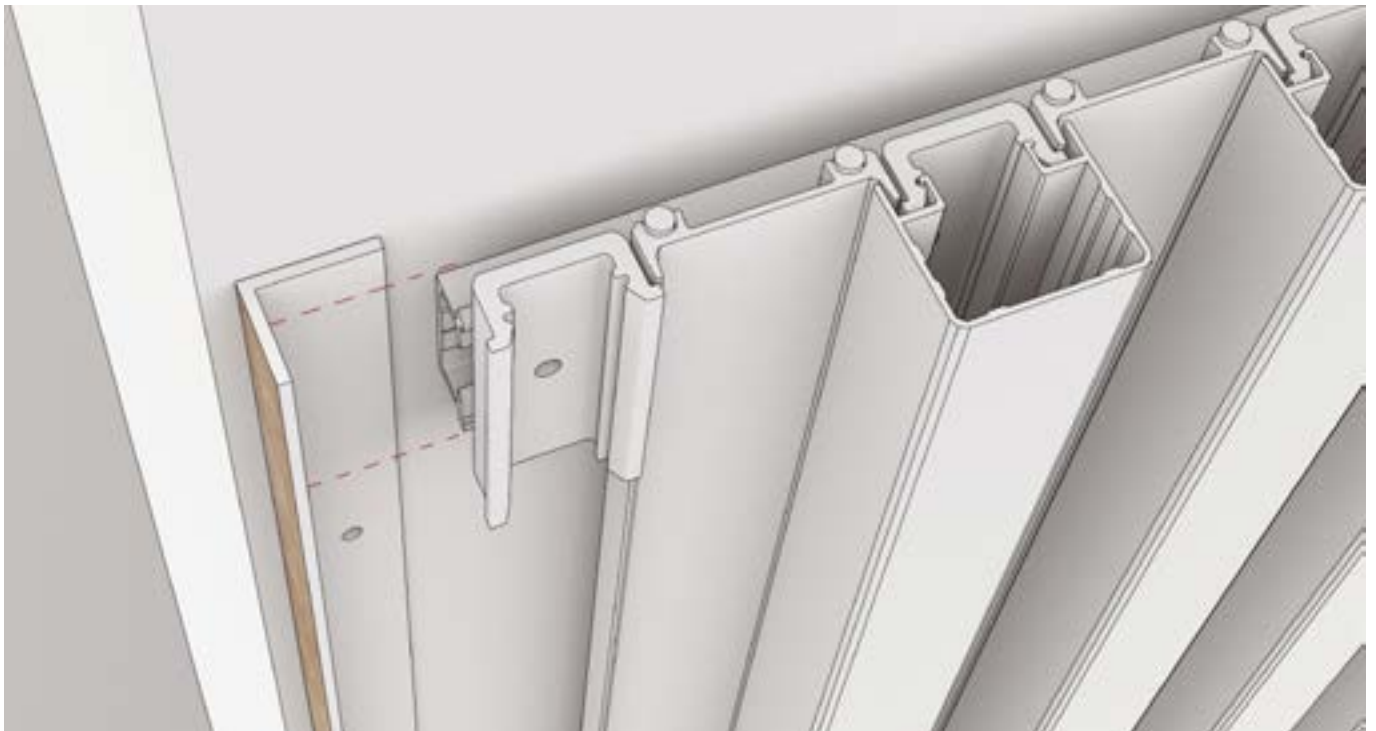

## STEP 3

Fix the L-profile with the appropriate screws.



Snap the last batten.



# STEP 3

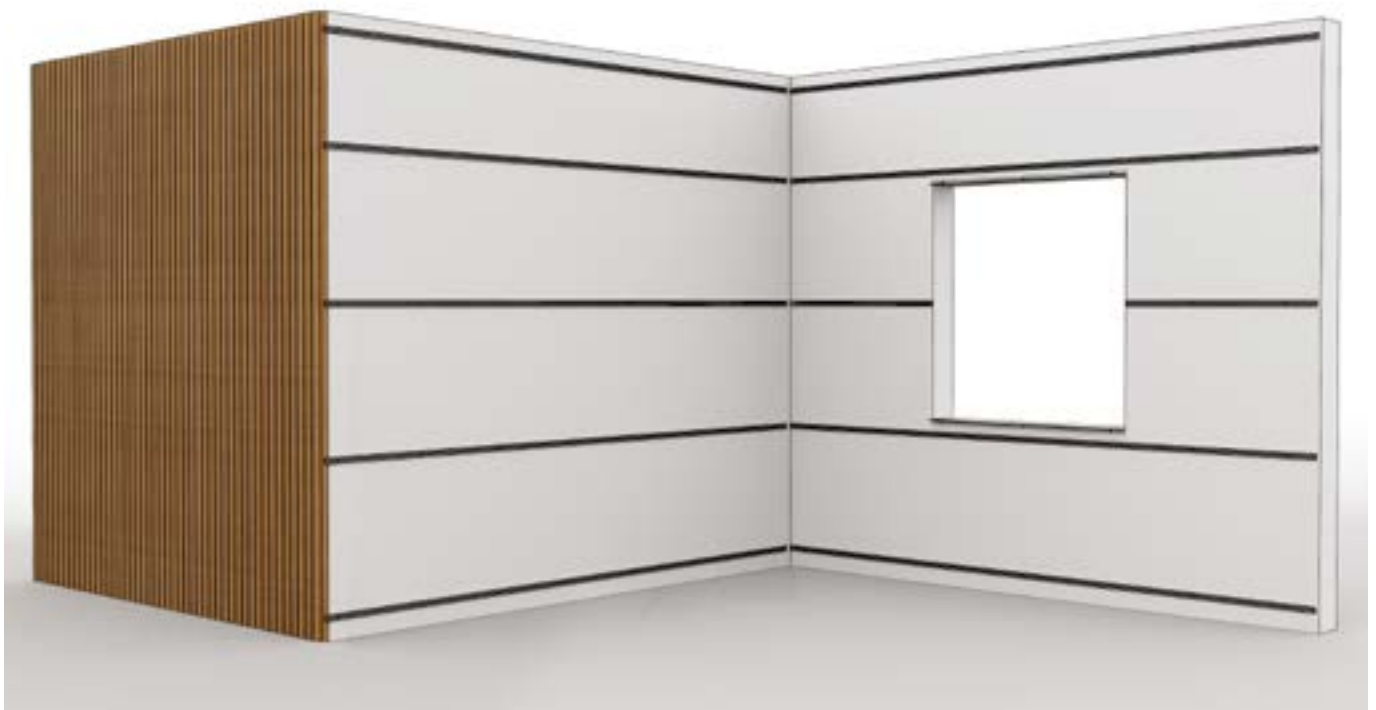

## STEP 4

Place the clip on the second wall in correspondence of the outer corner.



Rotate the clip by 90°.



# STEP 4

Move the clip as much outside as possible.



## STEP 4

Snap the corner batten (or a little piece of it) on the clip.



Move the batten until it is aligned with the battens previously installed.

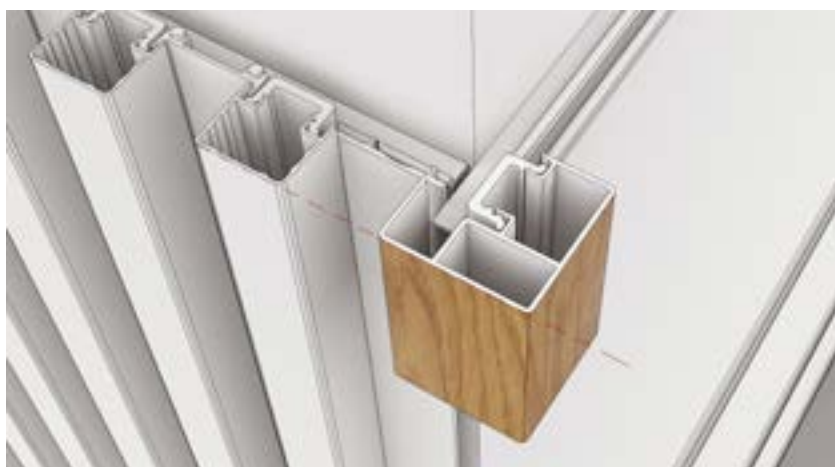
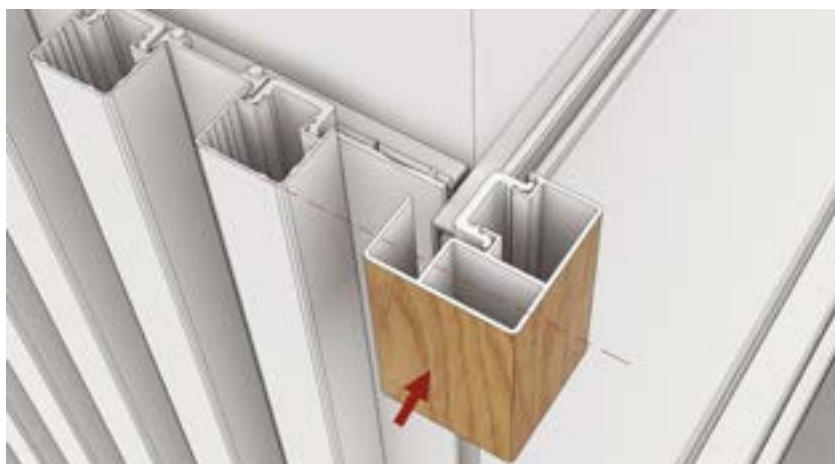

Then remove the corner batten.

# STEP 4

Place the first spacer.



# STEP 4

Snap the outer corner batten.

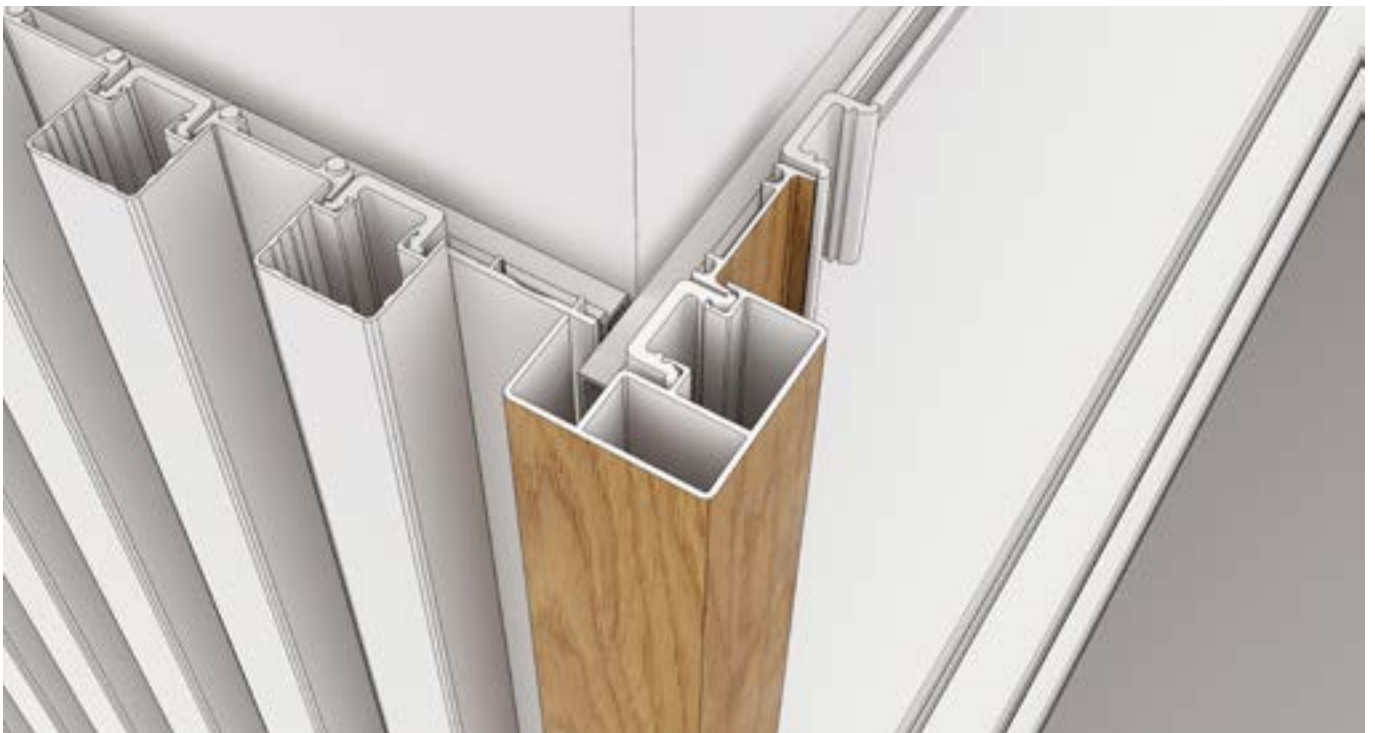
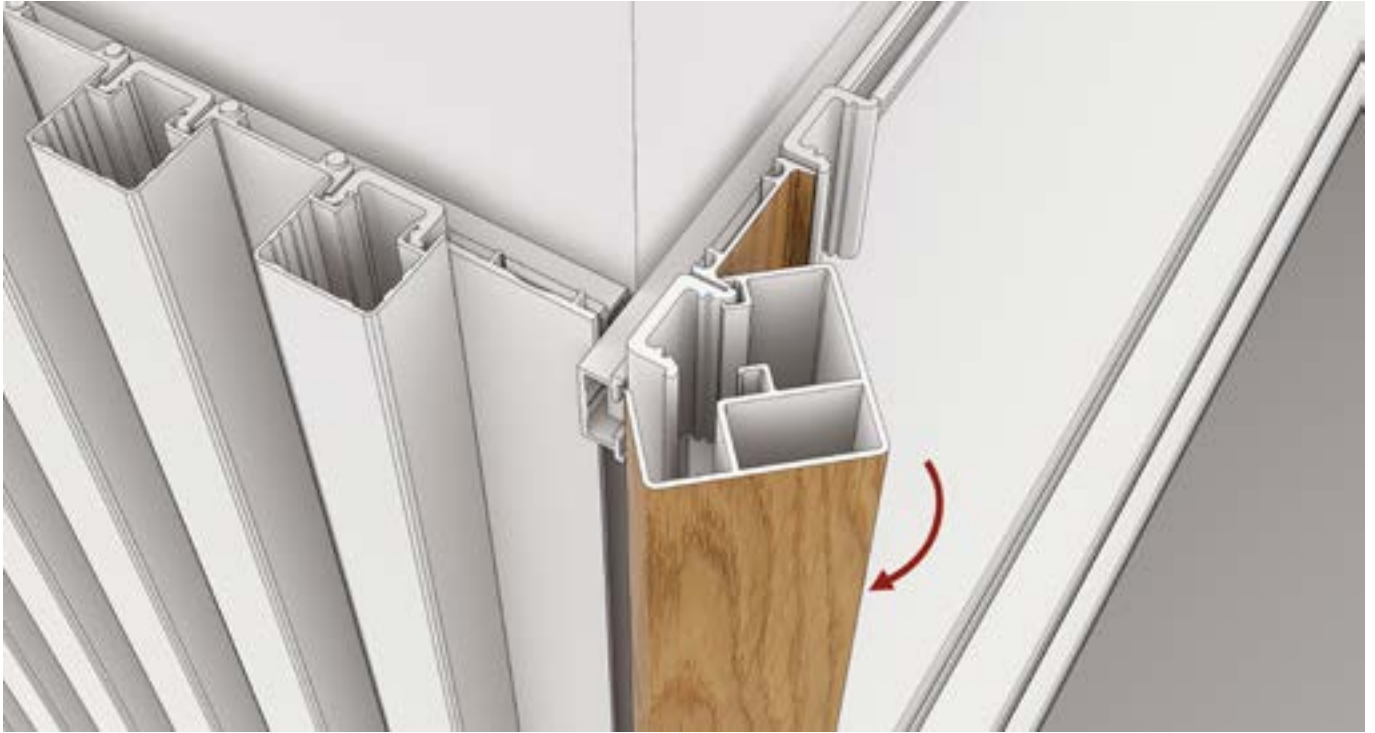

# STEP 4

Place all the spacers on the second wall.



# STEP 4

Snap all the battens except that near the inner corner.

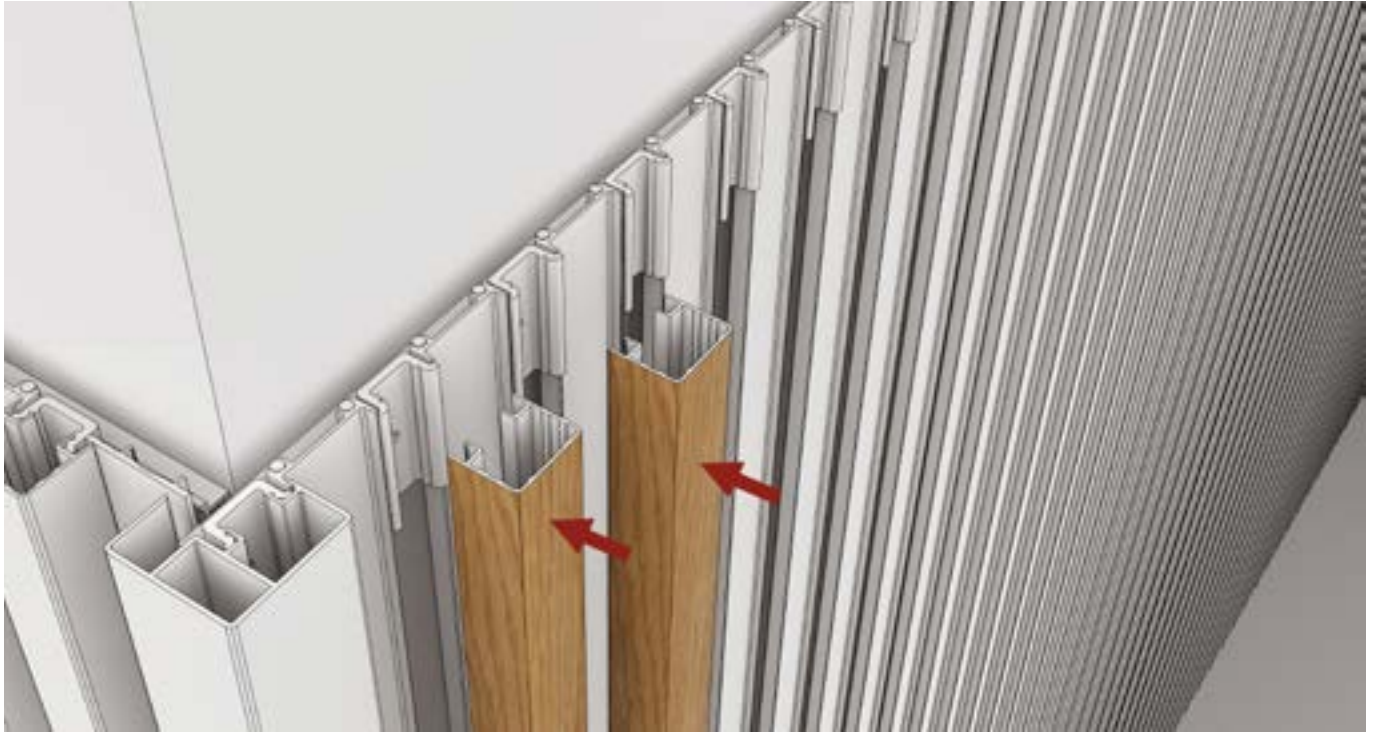

# STEP 4



## STEP 5

Place the clip on the third wall near the inner corner, as much inside as possible. Snap the batten and move it until it is aligned with the battens previously installed. Then remove the batten.

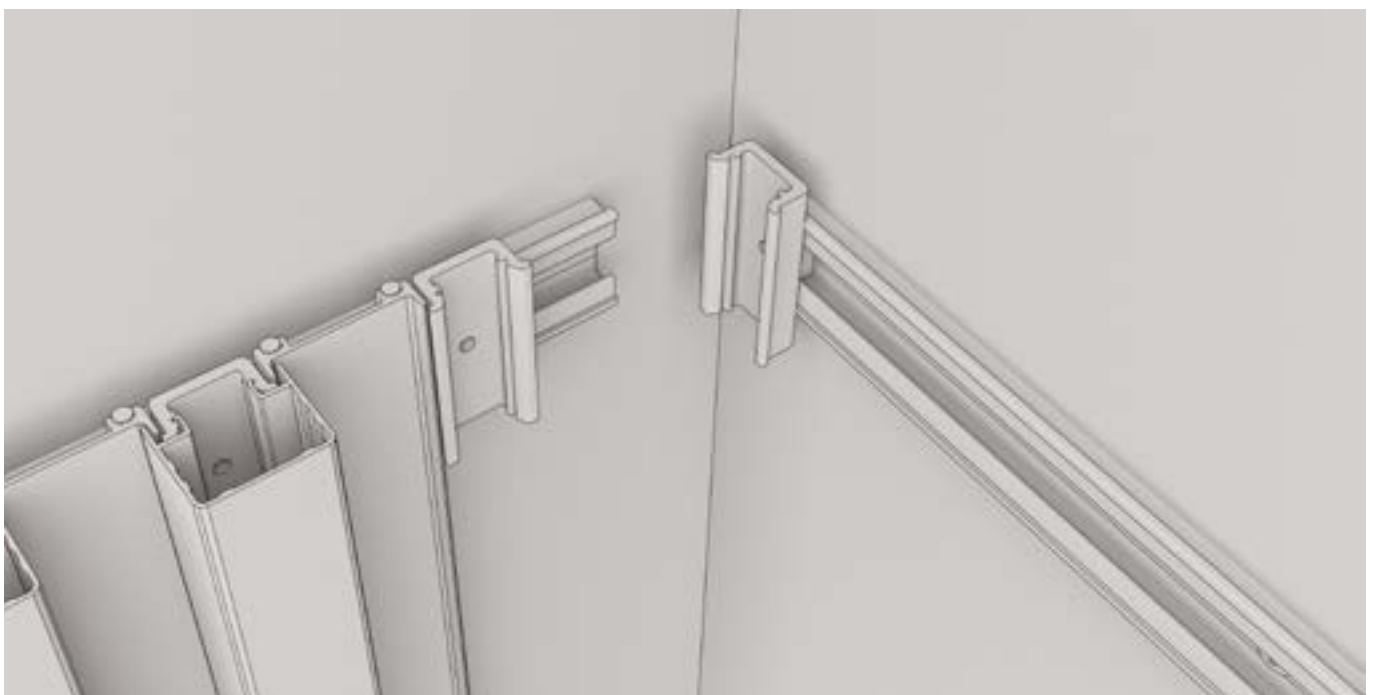
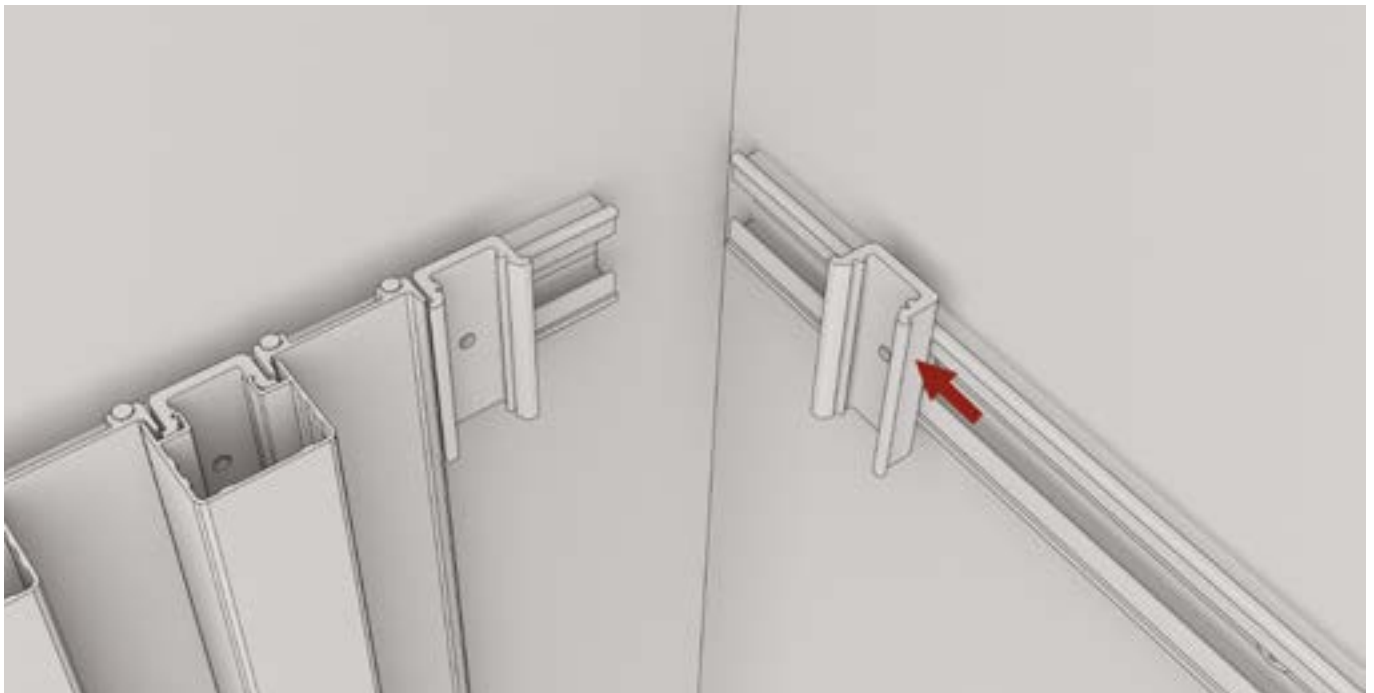

## STEP 5

Place the clip for complementary profiles on the second wall in correspondence of the inner corner.

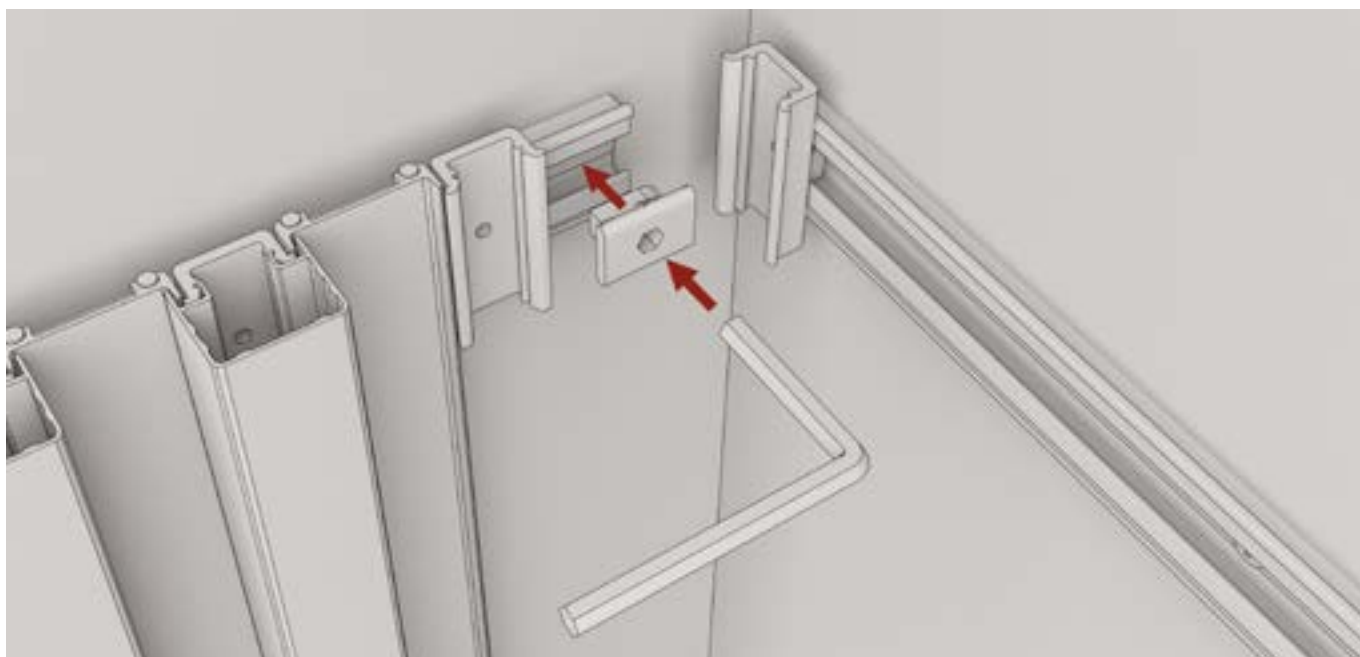

Rotate the clip by 90° with the metric hexagonal key (size 6 mm) in order to lock it into the fixing bar.

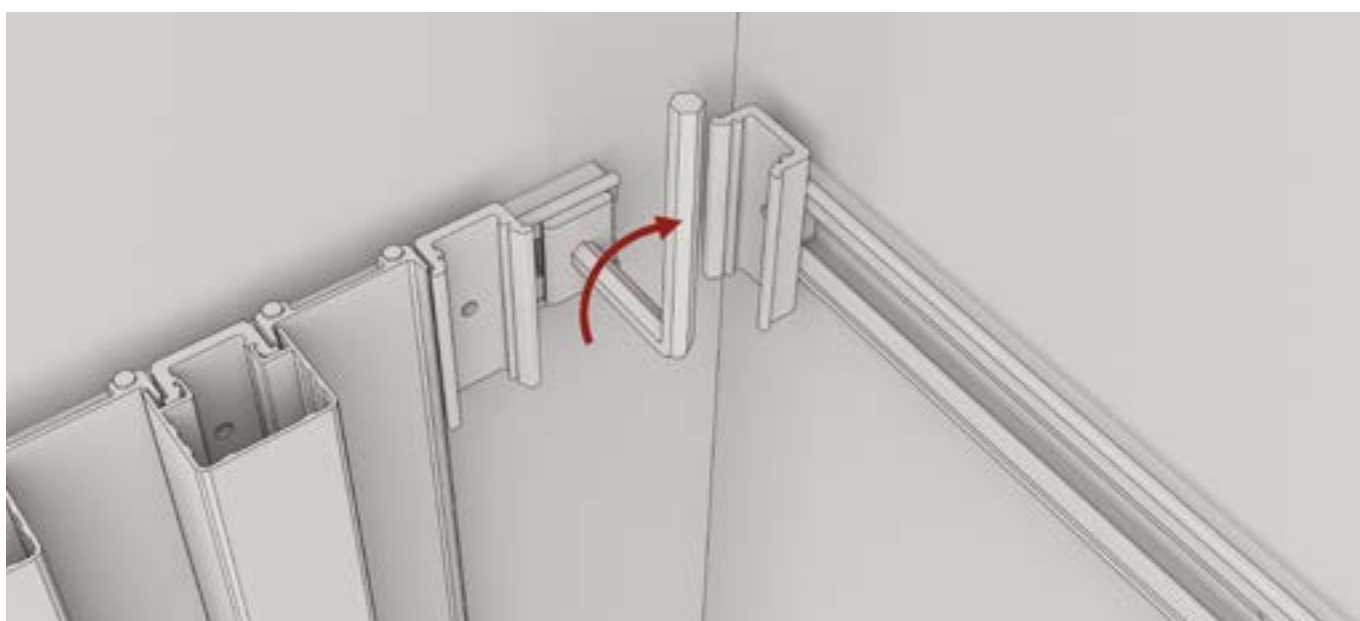

# STEP 5

Place the spacer on the third wall and lock it between the clips.

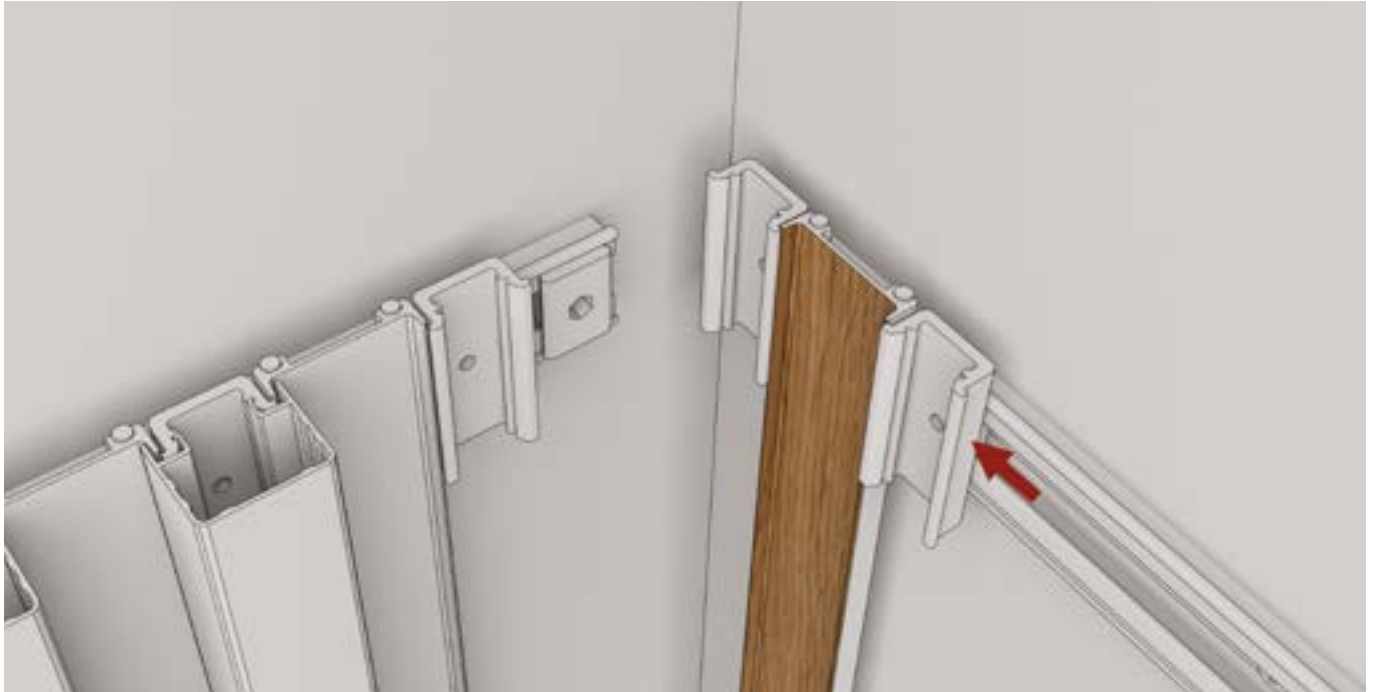

Snap the batten in correspondence of the inner corner.

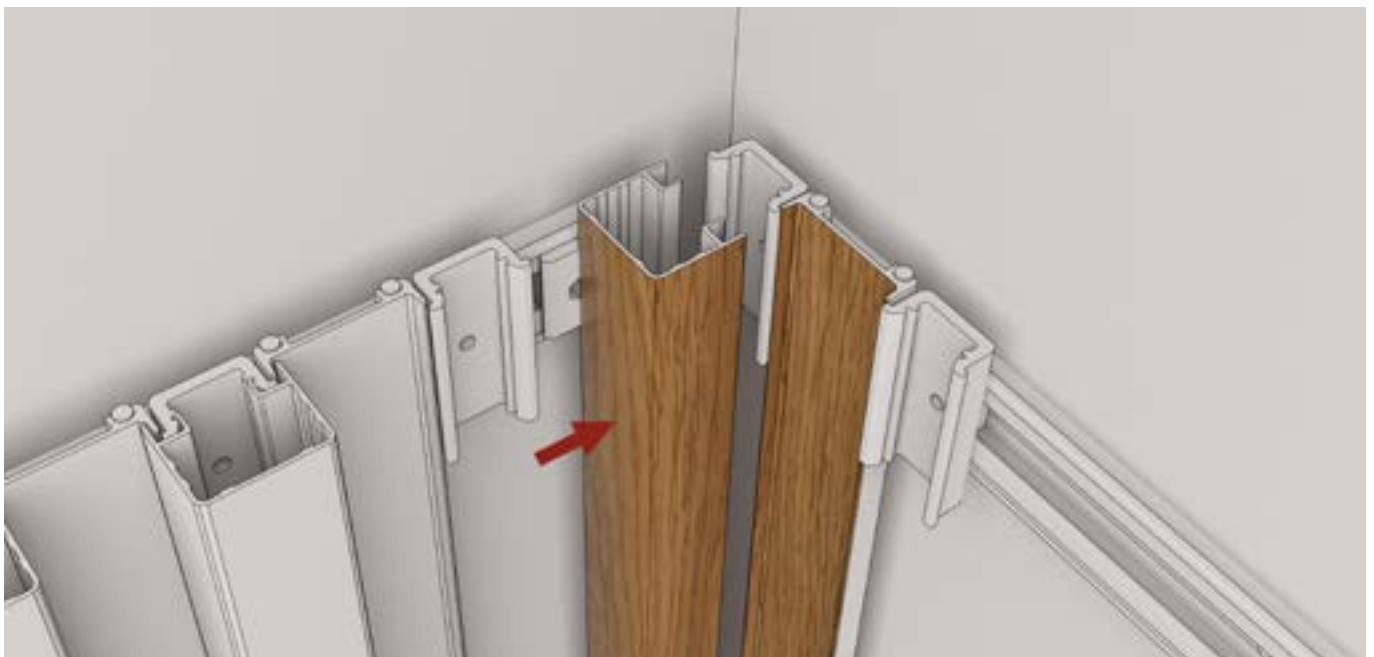

# STEP 5

Snap the end cut-to-size spacer on the clip near the inner corner.

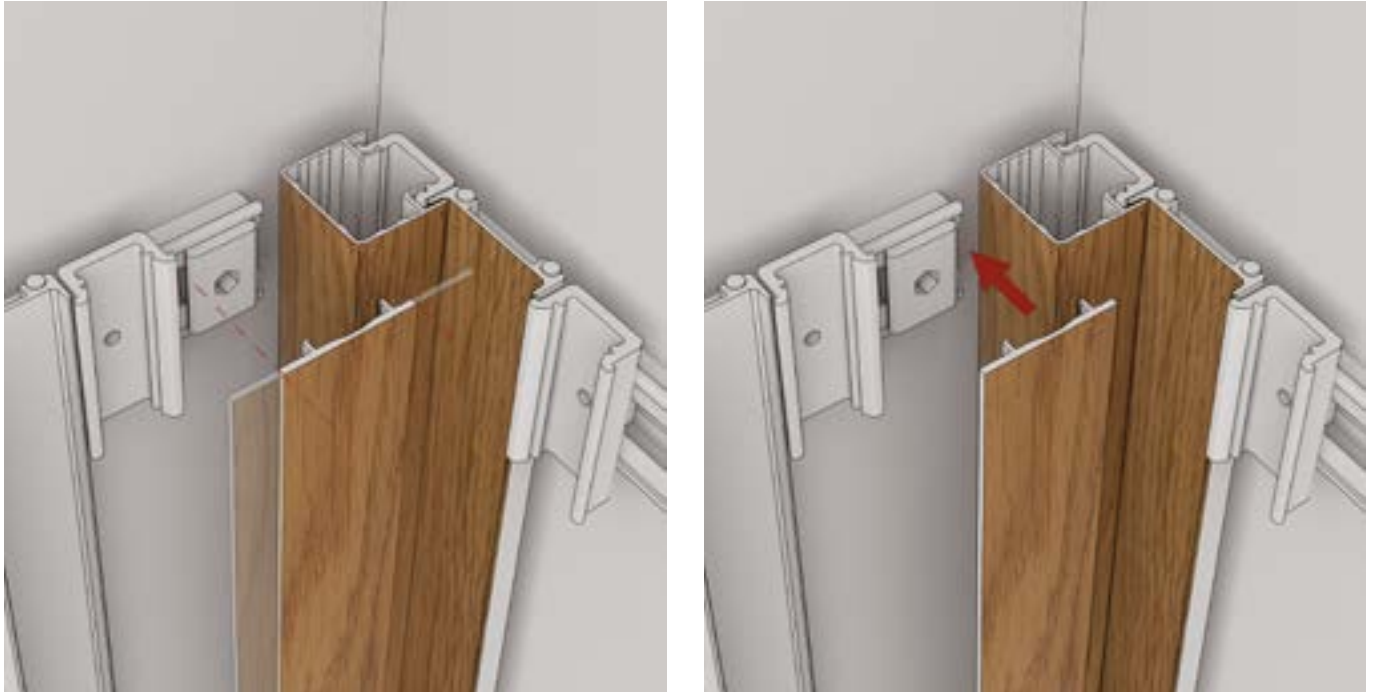

Snap the last batten on the second wall.

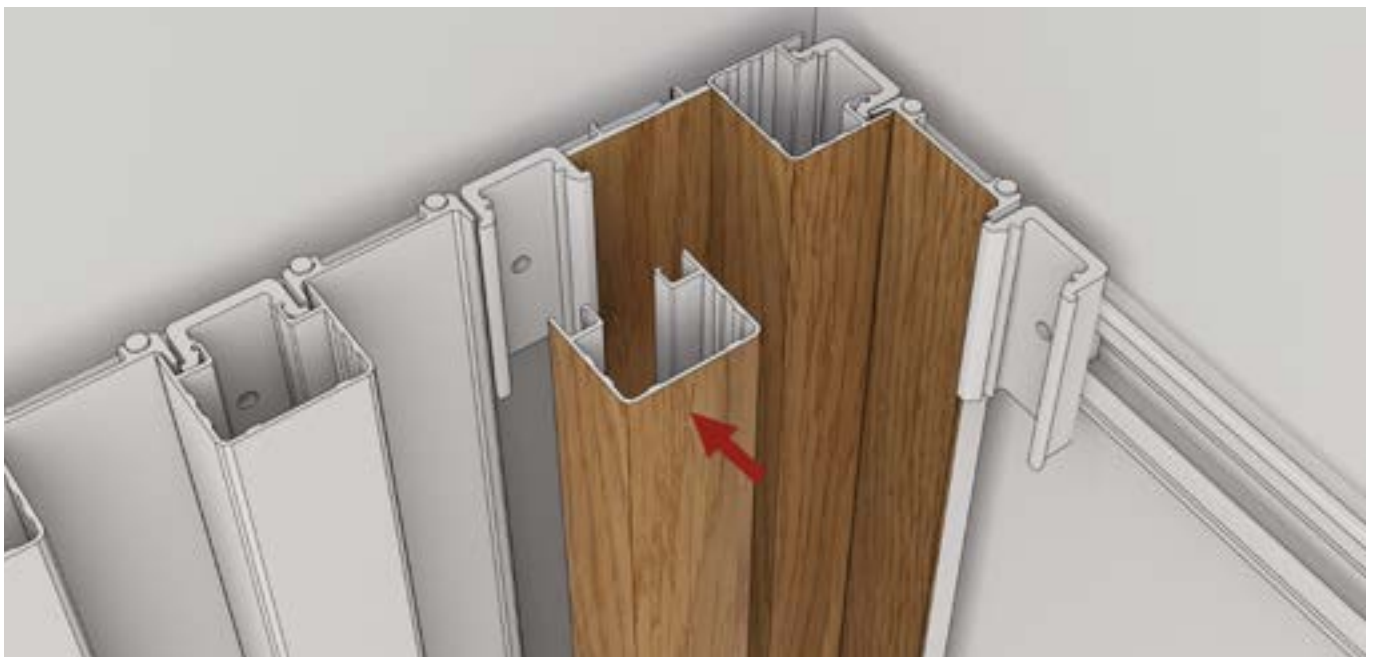

## STEP 5

Apply all the spacers on the third wall.



Snap all the battens except the last one.

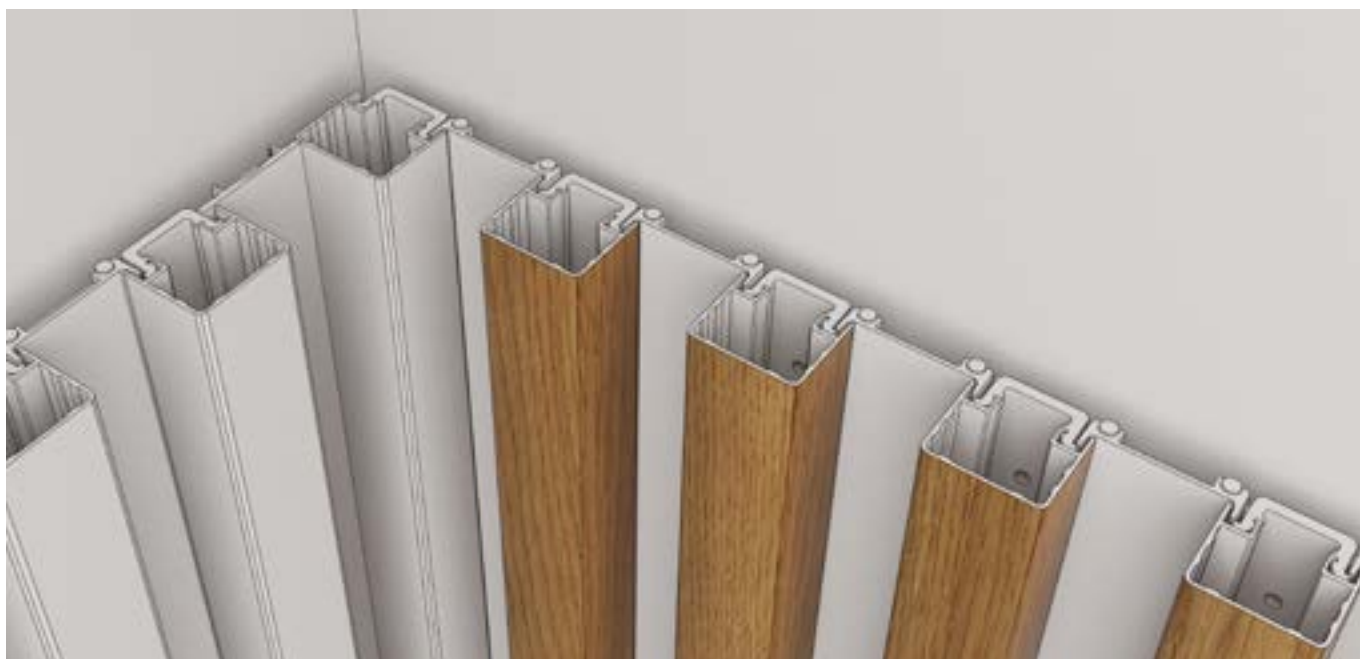

# STEP 5

If the wall cladding ends with the batten, use an angular profile for the lateral finishing. Get the L-profile closer to the fixing bar in order to detect the position of the notchings to make.



# STEP 5

Fix the L-profile with the appropriate screws.

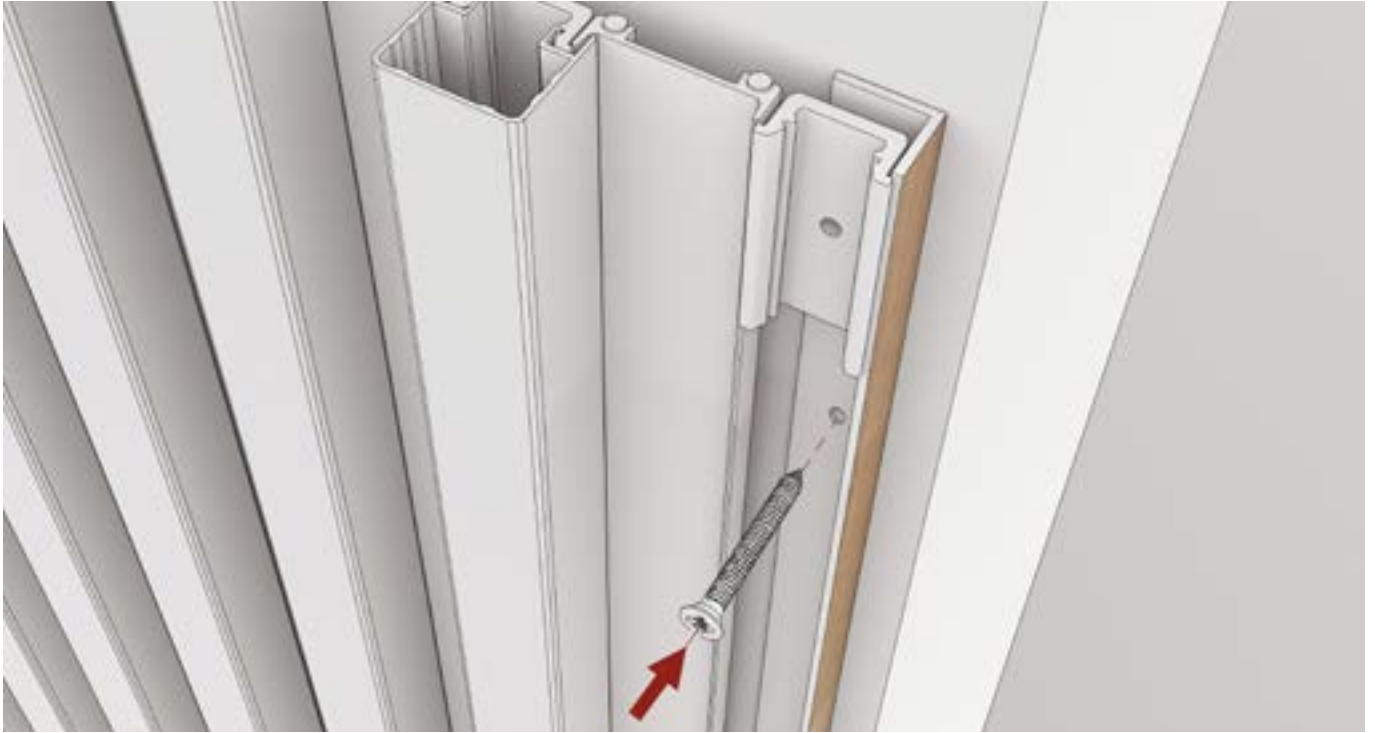

Snap the last batten.

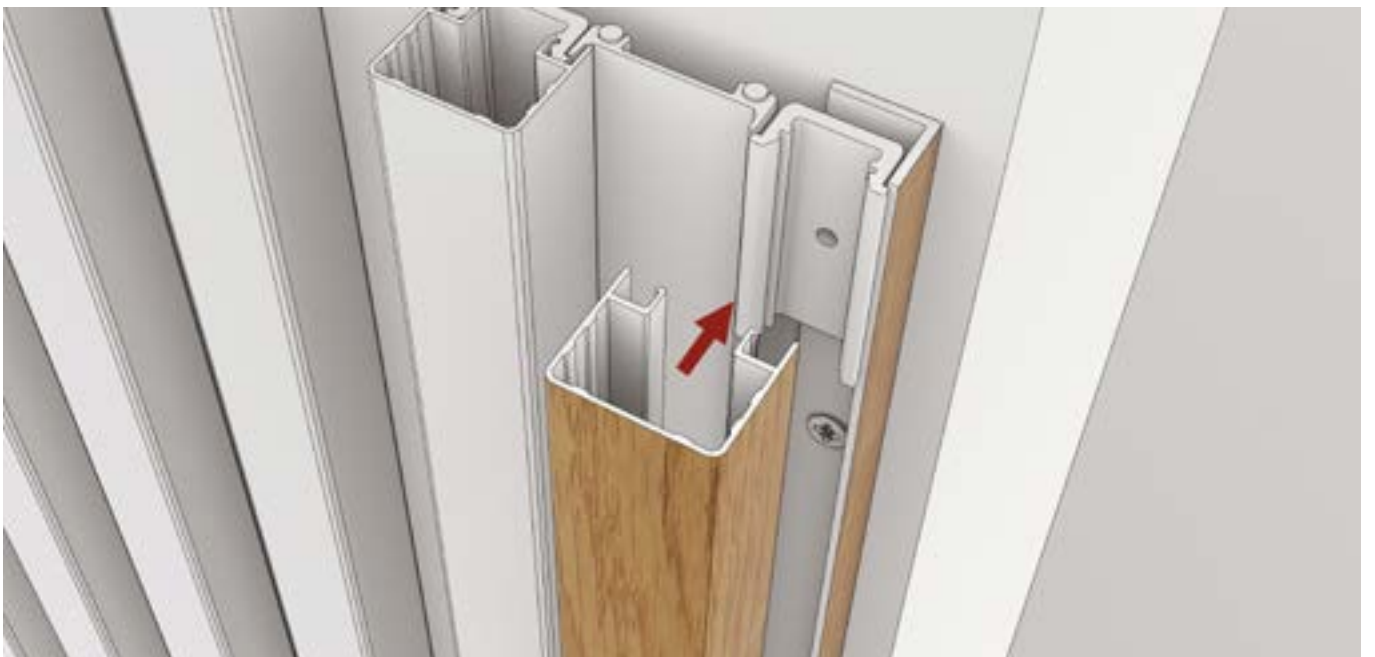

# STEP 6

Snap the caps on the free ends of the battens (for the outdoor cladding or near the windows for the application without spacers).

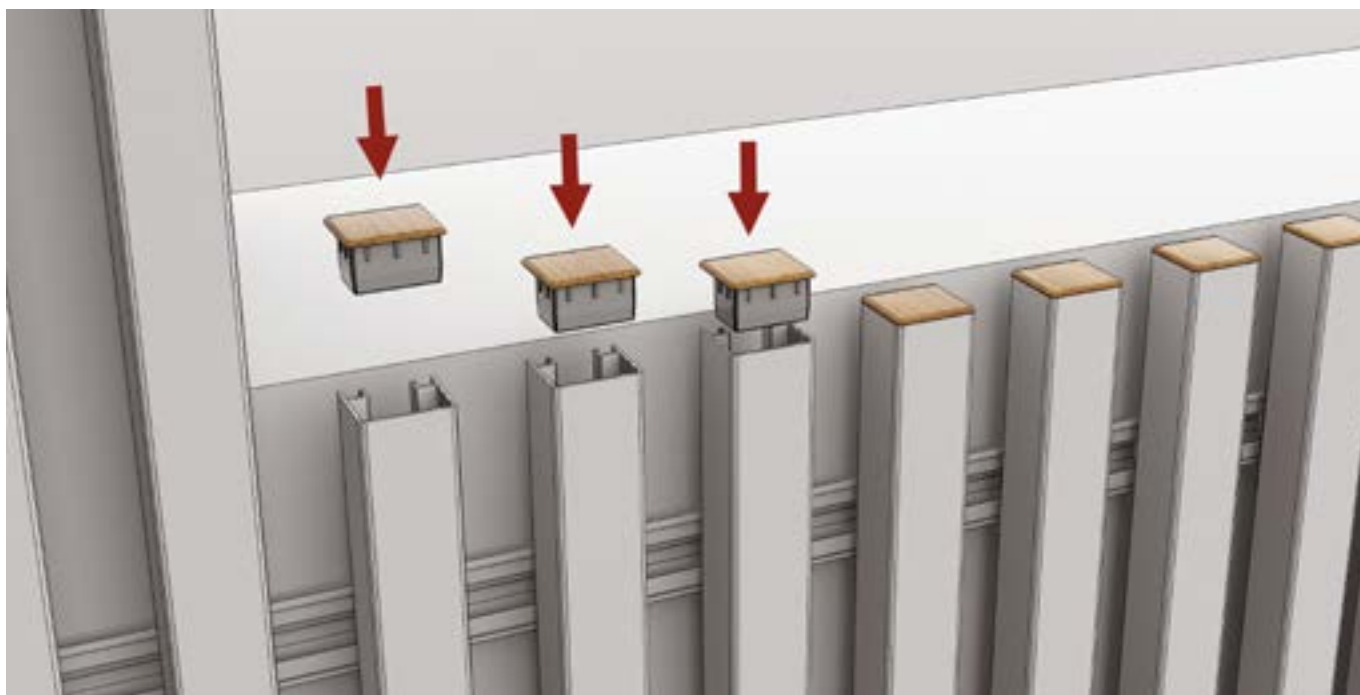

# STEP 6

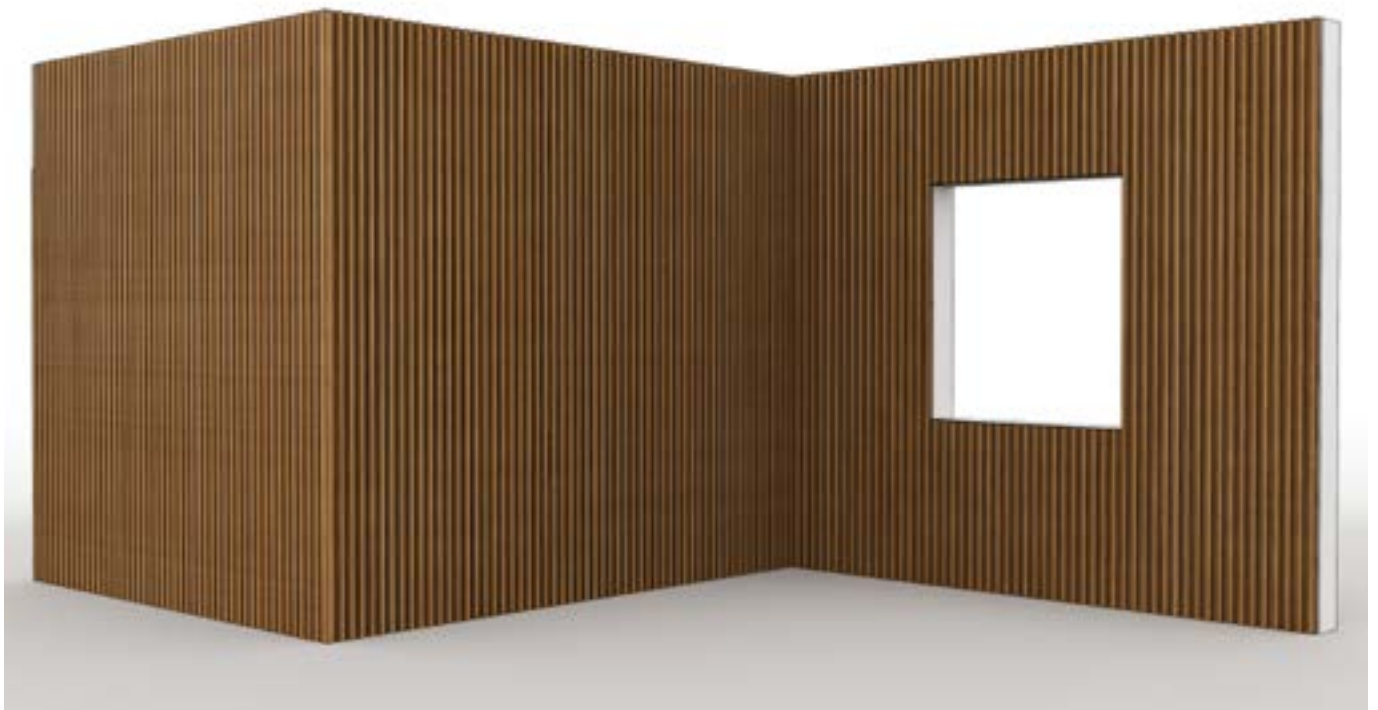

# Insights

The clip can be used as a linear joint between two battens.



# Insights

When battens are installed on the wall and the ceiling, near the corner they can be cut at 90° or 45° degrees. In the last case the battens are aligned with a corner joint.

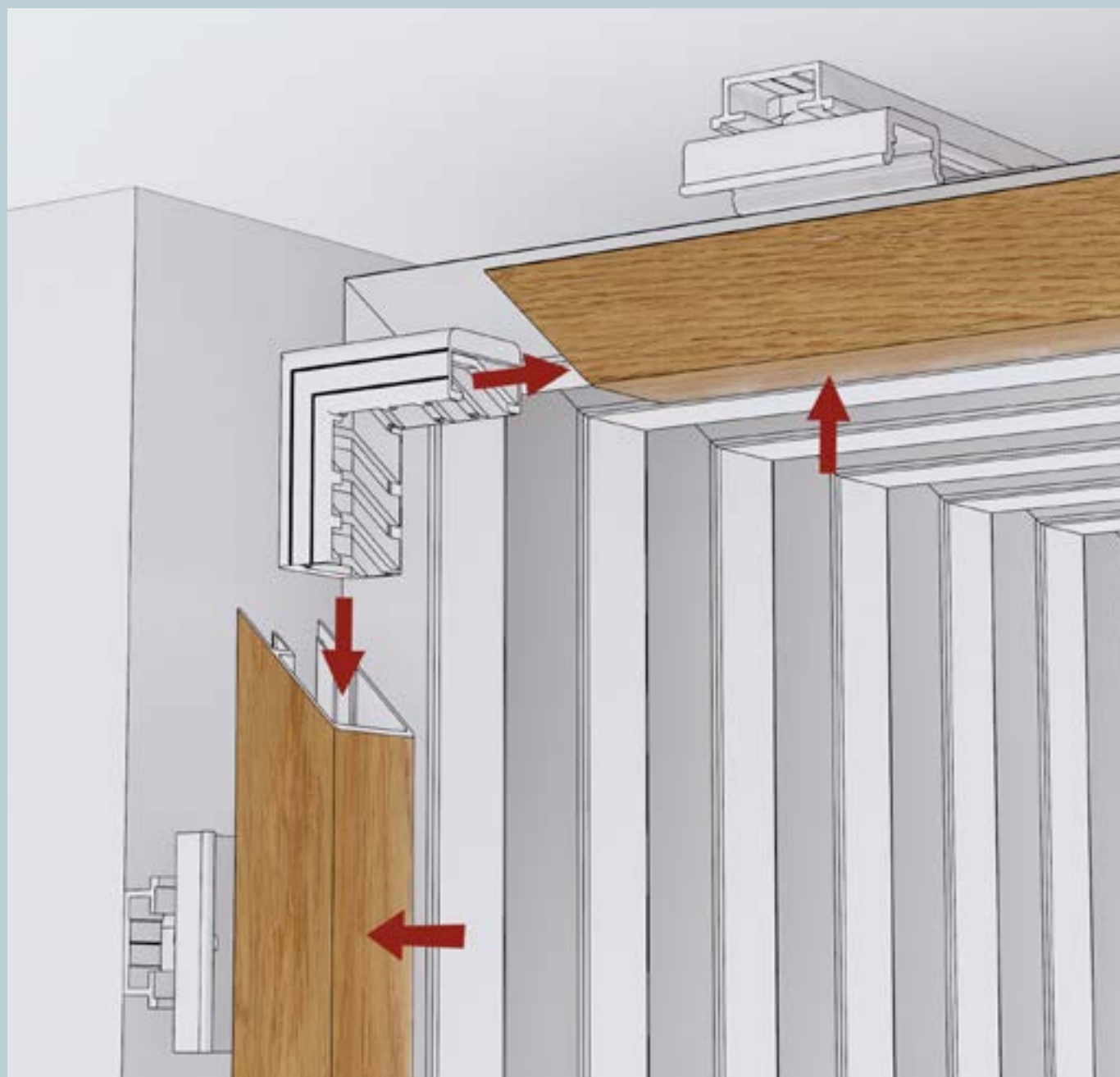

# Insights

The battens can be installed horizontally. In this case, near the corners, the corner joint must be used.



# SK N

Indoor & Outdoor  
Aluminum Wall Cladding

[formedesign.com](http://formedesign.com)

**FOR  
ME**  
DESIGN

**DFV**  
GROUP

S.S. 275 km. 14,400 - 73030 Surano (Le)  
tel. +39 0836 939328 - fax +39 0836 935270  
[info@formedesign.it](mailto:info@formedesign.it)

   [formedesign](http://formedesign.com)