

**BATTENS LIGHT**

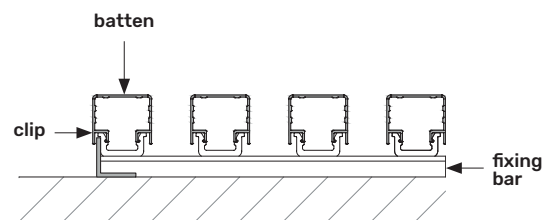
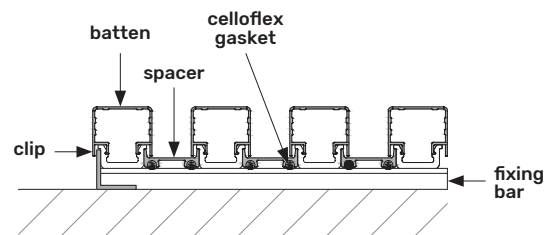

**BATTENS**

1.18"x0.98"-1.18"x2.95"-1.57"x0.98"-1.57"x2.95" Batten  
0.98"-2.95" corner batten  
0.98" end batten

**COVERS**

1.18"-2.95" cover  
Fixing bar cover

**RAILS**

Fixing bar  
Fixing bar for curved surface

**SPACERS**

0.79"-1.18"-1.57" spacer  
Cut-to-size spacer

**TRIMS**

Led holder profile  
Led holder for 0.98" batten  
Frame for 0.98" batten

**Standard lengths**

16' 9" (usable length 16' 6")  
21' 4" (usable length 21' 1")

**CLIPS AND CONNECTORS**

1.18" batten nylon clip (100 pcs/bag)  
1.57" batten nylon clip (100 pcs/bag)  
Complementary profiles clip (100 pcs/bag)  
Celloflex gasket (250 pcs/bag)  
1.18" corner joint (50 pcs/bag)  
1.57" corner joint (50 pcs/bag)  
Corner joint for open profiles (250 pcs/bag)  
Corner joint with outwards buttons (250 pcs/bag)  
Screen profile in polycarbonate L=9.84' (1 pc/bag)  
Right and left frame profile cap (1 pc/bag)

**CAPS**

1.18"x0.98"-1.18"x2.95"-1.57"x0.98"-1.57"x2.95" Batten cap  
0.98"-2.95" Corner batten cap

**FASTENING**

Stainless steel wood screws with countersunk flat head #10  
Stainless steel self-tapping screws with countersunk flat head #10  
Stainless steel self-drilling screws with countersunk flat head #10

**FINISHES**

Powder-on-powder wood-grain decoration  
Sublimated wood-grain decoration  
Exclusive digital printed wood-grain decoration  
Powder coated  
Anodized

**BIM&CAD**

RVT&DWG files available, see website for details

**PHYSICAL DATA**

6060/6063-T5 Extruded Aluminum  
100% Recyclable  
15 year warranty

**TESTING**

Experimental verification of resistance performance to wind load under dynamic pressure and impact resistance (IRCCOS-TCLab section of Building Future Lab located in the Mediterranean University of Reggio Calabria).

Reaction to fire test, Bending test on suspended ceilings and acoustic test (CSI located in Senago (MI)).



**Wind load**

Up to 148.6 ml/hr



**Resistance to soft body impact test**

Reference standard:  
EAD 090062-00-0404  
Category I



**Reaction to fire test**

Reference standards:  
EN 13823:2020  
EN ISO 1716:2018  
EN 13501-1:2019  
A2-S2-d0



**Bending test on suspended ceilings**

Reference standards:  
EN 13964:2014 Annex F § F.5.4

Declared additional load  
Class A/34.91 N/m<sup>2</sup>



**Acoustic test**

Reference standards:  
EN ISO 354:2003  
EN ISO 11654:1997

Weighted sound absorption coefficient 0.2

**BATTENS LIGHT**

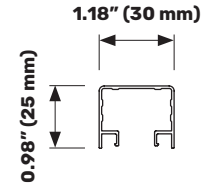
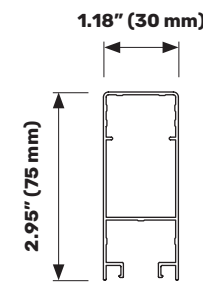
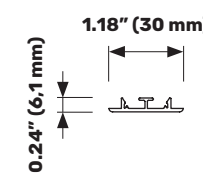
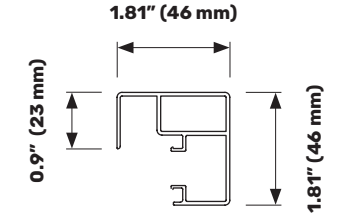
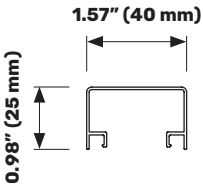
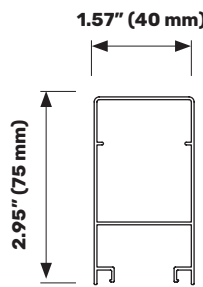
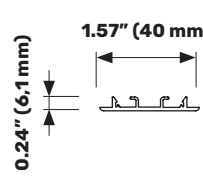
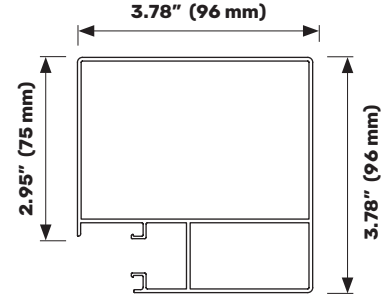
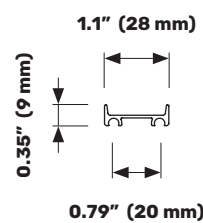
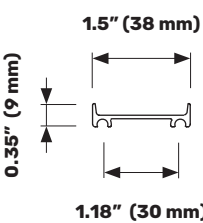
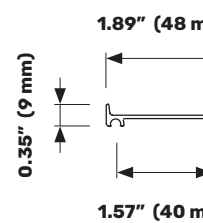
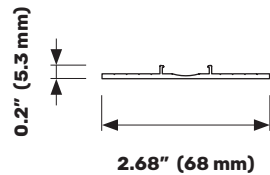
Battens			Corner battens	
 <p>1.18" (30 mm) 0.98" (25 mm)</p>	 <p>1.18" (30 mm) 2.95" (75 mm)</p>	 <p>1.18" (30 mm) 0.24" (6,1 mm)</p>	 <p>1.81" (46 mm) 0.9" (23 mm) 1.81" (46 mm)</p>	
<p>BA30026 1.18" x 0.98" Batten</p>	<p>BA30032 1.18" x 2.95" Batten</p>	<p>BA30021 1.18" Cover</p>	<p>BA30027 0.98" Corner batten</p>	
 <p>1.57" (40 mm) 0.98" (25 mm)</p>	 <p>1.57" (40 mm) 2.95" (75 mm)</p>	 <p>1.57" (40 mm) 0.24" (6,1 mm)</p>	 <p>3.78" (96 mm) 2.95" (75 mm) 3.78" (96 mm)</p>	
<p>BA40001 1.57" x 0.98" Batten</p>	<p>BA40002 1.57" x 2.95" Batten</p>	<p>BA40003 2.95" Cover</p>	<p>BA30028 2.95" Corner batten</p>	
Spacers				
 <p>1.1" (28 mm) 0.35" (9 mm) 0.79" (20 mm)</p>	 <p>1.5" (38 mm) 0.35" (9 mm) 1.18" (30 mm)</p>	 <p>1.89" (48 mm) 0.35" (9 mm) 1.57" (40 mm)</p>	 <p>0.2" (5,3 mm) 2.68" (68 mm)</p>	
<p>BA30001 0.79" Spacer</p>	<p>BA30017 1.18" Spacer</p>	<p>BA30018 1.57" Spacer</p>	<p>BA30033 Cut-to-size spacer</p>	

**BATTENS LIGHT**

Fixing bars		Finishing profiles	
<p>BA30002 Fixing bar</p>	<p>BA30019 Fixing bar cover</p>	<p>BA30024 End batten</p>	<p>BA30025 End cut-to-size spacer</p>
Led holder profiles			
<p>BA30008 Led holder for 0.98" batten</p>	<p>BA30007 Frame for 0.98" batten</p>	<p>BA30023 Led holder profile</p>	

**BATTENS LIGHT**

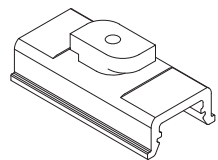

FA30001	<b>1.18" batten nylon clip</b>	Qty per bag 100
---------	--------------------------------	--------------------

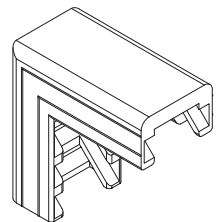

FA30004	<b>1.18" plastic corner joint</b>	Qty per bag 50
---------	-----------------------------------	-------------------

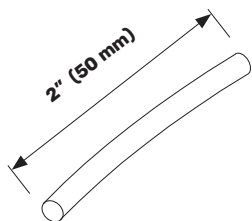

FA30005	<b>celloflex gasket</b>	Qty per bag 250
---------	-------------------------	--------------------



FA30006	<b>corner joint for open profiles</b>	Qty per bag 250
---------	---------------------------------------	--------------------

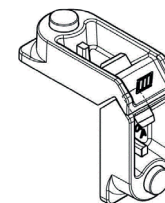

FA30007	<b>corner joint with outward buttons</b>	Qty per bag 250
---------	--	--------------------

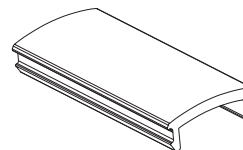

FA30008	<b>screen profile in polycarbonate L=9.84' (3000 mm)</b>	Qty per bag 1
---------	--	------------------

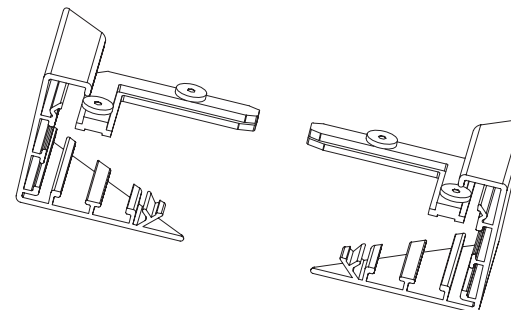

FA30009	<b>right and left frame profile cap</b>	Qty per bag 1
---------	---	------------------

**BATTENS LIGHT**



		Qty per bag
FA30010_1013	<b>1.18" x 0.98" batten cap, RAL 1013</b>	50
FA30010_7001	<b>1.18" x 0.98" batten cap, RAL 7001</b>	50
FA30010_8017	<b>1.18" x 0.98" batten cap, RAL 8017</b>	50
FA30010_8023	<b>1.18" x 0.98" batten cap, RAL 8023</b>	50
FA30010_9005	<b>1.18" x 0.98" batten cap, RAL 9005</b>	50
FA30010_9010	<b>1.18" x 0.98" batten cap, RAL 9010</b>	50
FA30010_EXC	<b>1.18" x 0.98" batten cap, Exclusive digital printed wood-grain decoration</b>	50

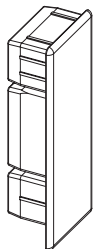

		Qty per bag
FA30011_1013	<b>1.18" x 2.95" batten cap, RAL 1013</b>	50
FA30011_7001	<b>1.18" x 2.95" batten cap, RAL 7001</b>	50
FA30011_8017	<b>1.18" x 2.95" batten cap, RAL 8017</b>	50
FA30011_8023	<b>1.18" x 2.95" batten cap, RAL 8023</b>	50
FA30011_9005	<b>1.18" x 2.95" batten cap, RAL 9005</b>	50
FA30011_9010	<b>1.18" x 2.95" batten cap, RAL 9010</b>	50
FA30011_EXC	<b>1.18" x 2.95" batten cap, Exclusive digital printed wood-grain decoration</b>	50

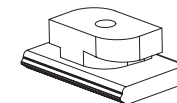

		Qty per bag
FA30013	<b>complementary profiles clip</b>	100

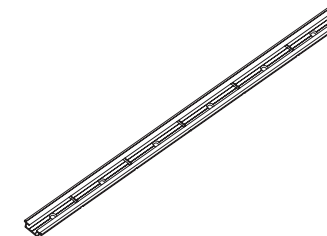

		Qty per bag
FA30015	<b>support profile for curved surfaces L=3.28' (1000 mm)</b>	1

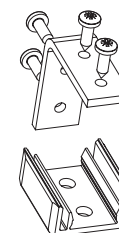

		Qty per bag
FA30016	<b>corner bracket kit for 1.57" x 2.95" batten</b>	25

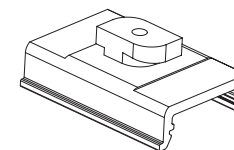

		Qty per bag
FA40001	<b>1.57" batten nylon clip</b>	100

**BATTENS LIGHT**

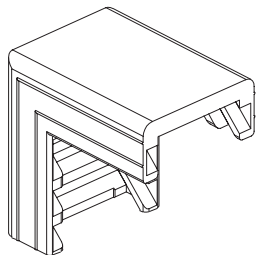

		Qty per bag
FA40005	<b>1.57" plastic corner joint</b>	50

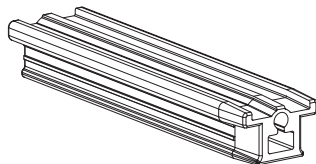

		Qty per bag
FA30021	<b>safety device for 1.18" batten</b>	50

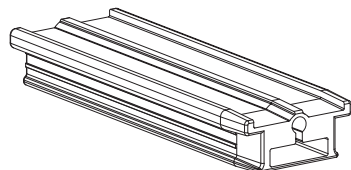

		Qty per bag
FA40006	<b>safety device for 1.57" batten</b>	50



		Qty per bag
FA40003_1013	<b>1.57" x 0.98" batten cap, RAL 1013</b>	50
FA40003_7001	<b>1.57" x 0.98" batten cap, RAL 7001</b>	50
FA40003_8017	<b>1.57" x 0.98" batten cap, RAL 8017</b>	50
FA40003_8023	<b>1.57" x 0.98" batten cap, RAL 8023</b>	50
FA40003_9005	<b>1.57" x 0.98" batten cap, RAL 9005</b>	50
FA40003_9010	<b>1.57" x 0.98" batten cap, RAL 9010</b>	50
FA40003_EXC	<b>1.57" x 0.98" batten cap, Exclusive digital printed wood-grain decoration</b>	50

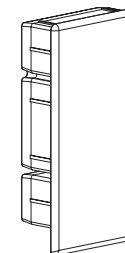

		Qty per bag
FA40004_1013	<b>1.18" x 2.95" batten cap, RAL 1013</b>	50
FA40004_7001	<b>1.18" x 2.95" batten cap, RAL 7001</b>	50
FA40004_8017	<b>1.18" x 2.95" batten cap, RAL 8017</b>	50
FA40004_8023	<b>1.18" x 2.95" batten cap, RAL 8023</b>	50
FA40004_9005	<b>1.18" x 2.95" batten cap, RAL 9005</b>	50
FA40004_9010	<b>1.18" x 2.95" batten cap, RAL 9010</b>	50
FA40004_EXC	<b>1.18" x 2.95" batten cap, Exclusive digital printed wood-grain decoration</b>	50

**BATTENS LIGHT**

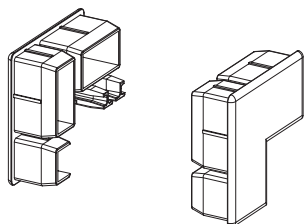

		Qty per bag
FA30022_9005	<b>0.98" corner batten cap, RAL 9005</b>	1
FA30022/EXC	<b>0.98" corner batten cap, RAL Exclusive, Ezy and Sublimated decorations</b>	1

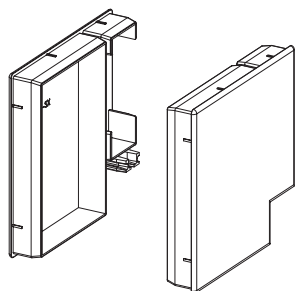

		Qty per bag
FA30023_9005	<b>2.95" corner batten cap, RAL 9005</b>	1
FA30023/EXC	<b>2.95" corner batten cap, RAL Exclusive, Ezy and Sublimated decorations</b>	1

**BATTENS LIGHT**

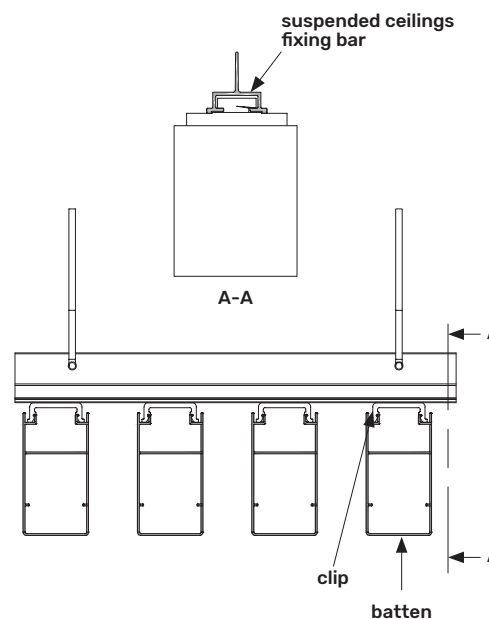
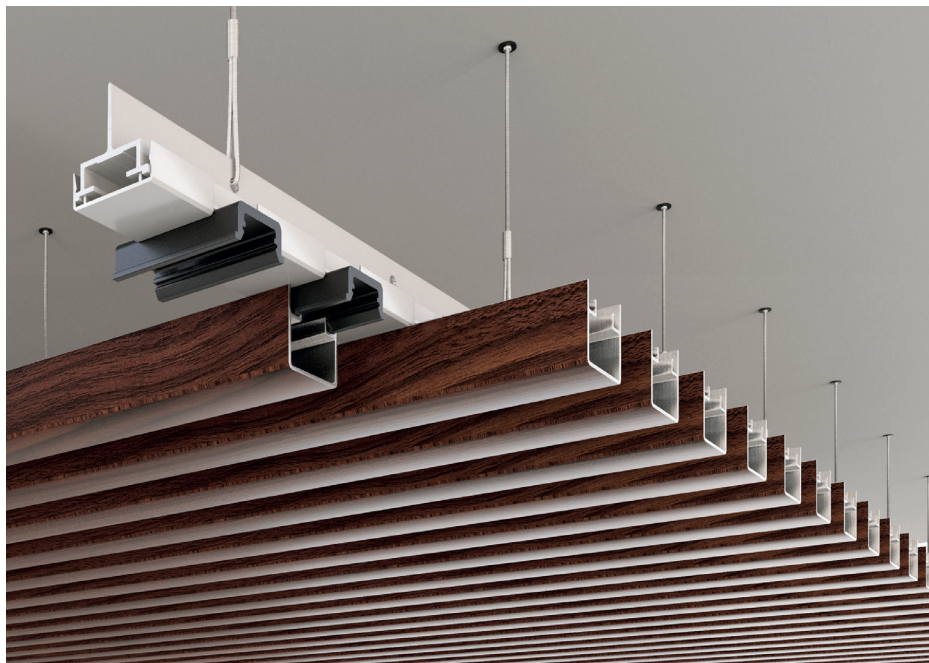

**BATTENS**

1.18"x0.98"-1.18"x2.95"-1.57"x0.98"-1.57"x2.95" batten

**COVERS**

Fixing bar cover

**RAILS**

Suspended ceilings fixing bar

**SPACERS**

0.79" - 1.18" - 1.57" spacer  
Cut-to-size spacer

**TRIMS**

Led holder profile

Standard lengths

16' 9" (usable length 16'6")

21' 4" (usable length 21'1")

**CLIPS AND CONNECTORS**

1.18" batten nylon clip (100 pcs/bag)

1.57" batten nylon clip (100 pcs/bag)

Complementary profiles clip (100 pcs/bag)

Celloflex gasket (250 pcs/bag)

Hanging wire with spring (1 pc/bag)

Hanging wire with open eyelet (1 pc/bag)

**CAPS**

1.18"x0.98"-1.18"x2.95"-1.57"x0.98"-1.57"x2.95" Batten cap

**FINISHES**

Powder-on-powder wood-grain decoration

Sublimated wood-grain decoration

Exclusive digital printed wood-grain decoration

Powder coated

Anodized

**BIM&CAD**

RVT&DWG files available, see website for details

**PHYSICAL DATA**

6060/6063-T5 Extruded Aluminum

100% Recyclable

15 year warranty

**TESTING**

Experimental verification of resistance performance to wind load under dynamic pressure and impact resistance (IRCCOS-TCLab section of Building Future Lab located in the Mediterranean University of Reggio Calabria).

Reaction to fire test, Bending test on suspended ceilings and acoustic test (CSI located in Senago (MI)).



**Wind load**

Up to 148.6 ml/hr



**Resistance to soft body impact test**

Reference standard:  
EAD 090062-00-0404  
Category I



**Reaction to fire test**

Reference standards:  
EN 13823:2020  
EN ISO 1716:2018  
EN 13501-1:2019  
A2-S2-d0



**Bending test on suspended ceilings**

Reference standards:  
EN 13964:2014 Annex F § F.5.4

Declared additional load  
Class A/34.91 N/m<sup>2</sup>



**Acoustic test**

Reference standards:  
EN ISO 354:2003  
EN ISO 11654:1997

Weighted sound  
absorption coefficient 0.2

**BATTENS LIGHT**

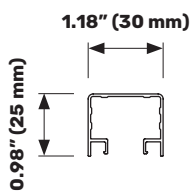
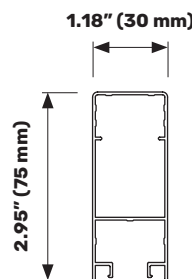
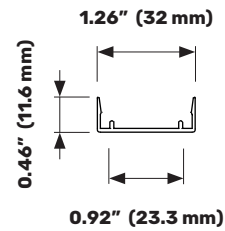
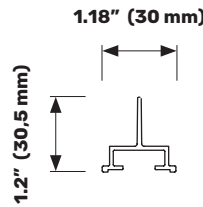
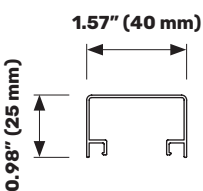
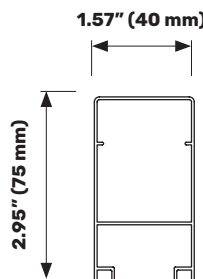
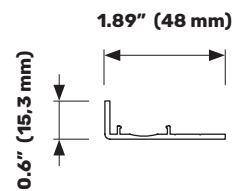
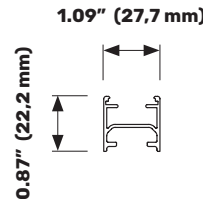
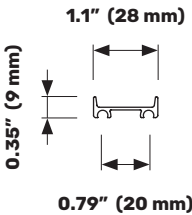
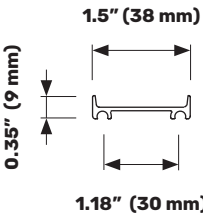
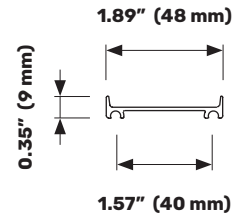
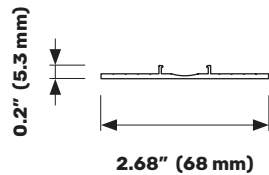
Battens		Fixing bars	
 <p>1.18" (30 mm) 0.98" (25 mm)</p>	 <p>1.18" (30 mm) 2.95" (75 mm)</p>	 <p>1.26" (32 mm) 0.46" (11.6 mm) 0.92" (23.3 mm)</p>	 <p>1.18" (30 mm) 1.2" (30.5 mm)</p>
<p>BA30026 1.18" x 0.98" Batten</p>	<p>BA30032 1.18" x 2.95" Batten</p>	<p>BA30019 Fixing bar cover</p>	<p>BA30020 Suspended ceilings fixing bar</p>
 <p>1.57" (40 mm) 0.98" (25 mm)</p>	 <p>1.57" (40 mm) 2.95" (75 mm)</p>	 <p>1.89" (48 mm) 0.6" (15.3 mm)</p>	 <p>1.09" (27.7 mm) 0.87" (22.2 mm)</p>
<p>BA40001 1.57" x 0.98" Batten</p>	<p>BA40002 1.57" x 2.95" Batten</p>	<p>BA30025 End cut-to-size spacer</p>	<p>BA30023 Led holder profile</p>
Spacers		Spacers	
 <p>1.1" (28 mm) 0.35" (9 mm) 0.79" (20 mm)</p>	 <p>1.5" (38 mm) 0.35" (9 mm) 1.18" (30 mm)</p>	 <p>1.89" (48 mm) 0.35" (9 mm) 1.57" (40 mm)</p>	 <p>0.2" (5.3 mm) 2.68" (68 mm)</p>
<p>BA30001 0.79" Spacer</p>	<p>BA30017 1.18" Spacer</p>	<p>BA30018 1.57" Spacer</p>	<p>BA30033 Cut-to-size spacer</p>

**BATTENS LIGHT**

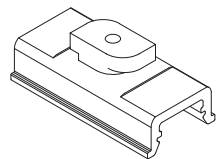

		Qty per bag
FA30001	<b>1.18" batten nylon clip</b>	100

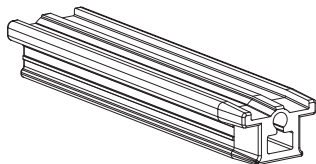

		Qty per bag
FA30021	<b>safety device for 1.18" batten</b>	50

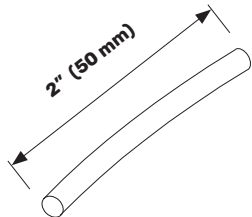

		Qty per bag
FA30005	<b>celloflex gasket</b>	250

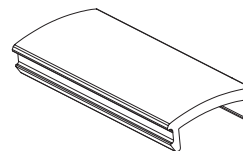

		Qty per bag
FA30008	<b>screen profile in polycarbonate L=9.84' (3000 mm)</b>	1

**BATTENS LIGHT**



		Qty per bag
FA30010_1013	<b>1.18" x 0.98" batten cap, RAL 1013</b>	50
FA30010_7001	<b>1.18" x 0.98" batten cap, RAL 7001</b>	50
FA30010_8017	<b>1.18" x 0.98" batten cap, RAL 8017</b>	50
FA30010_8023	<b>1.18" x 0.98" batten cap, RAL 8023</b>	50
FA30010_9005	<b>1.18" x 0.98" batten cap, RAL 9005</b>	50
FA30010_9010	<b>1.18" x 0.98" batten cap, RAL 9010</b>	50
FA30010_EXC	<b>1.18" x 0.98" batten cap, Exclusive digital printed wood-grain decoration</b>	50

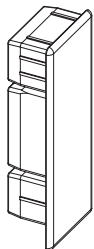

		Qty per bag
FA30011_1013	<b>1.18" x 2.95" batten cap, RAL 1013</b>	50
FA30011_7001	<b>1.18" x 2.95" batten cap, RAL 7001</b>	50
FA30011_8017	<b>1.18" x 2.95" batten cap, RAL 8017</b>	50
FA30011_8023	<b>1.18" x 2.95" batten cap, RAL 8023</b>	50
FA30011_9005	<b>1.18" x 2.95" batten cap, RAL 9005</b>	50
FA30011_9010	<b>1.18" x 2.95" batten cap, RAL 9010</b>	50
FA30011_EXC	<b>1.18" x 2.95" batten cap, Exclusive digital printed wood-grain decoration</b>	50

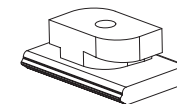

		Qty per bag
FA30013	<b>complementary profiles clip</b>	100

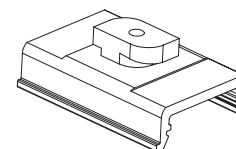

		Qty per bag
FA40001	<b>1.57" batten nylon clip</b>	100

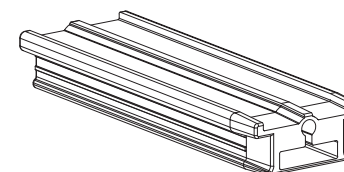

		Qty per bag
FA40006	<b>safety device for 1.57" batten</b>	50

**BATTENS LIGHT**



		Qty per bag
FA40003_1013	<b>1.57" x 0.98" batten cap, RAL 1013</b>	50
FA40003_7001	<b>1.57" x 0.98" batten cap, RAL 7001</b>	50
FA40003_8017	<b>1.57" x 0.98" batten cap, RAL 8017</b>	50
FA40003_8023	<b>1.57" x 0.98" batten cap, RAL 8023</b>	50
FA40003_9005	<b>1.57" x 0.98" batten cap, RAL 9005</b>	50
FA40003_9010	<b>1.57" x 0.98" batten cap, RAL 9010</b>	50
FA40003_EXC	<b>1.57" x 0.98" batten cap, Exclusive digital printed wood-grain decoration</b>	50

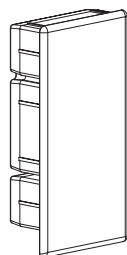

		Qty per bag
FA40004_1013	<b>1.18" x 2.95" batten cap, RAL 1013</b>	50
FA40004_7001	<b>1.18" x 2.95" batten cap, RAL 7001</b>	50
FA40004_8017	<b>1.18" x 2.95" batten cap, RAL 8017</b>	50
FA40004_8023	<b>1.18" x 2.95" batten cap, RAL 8023</b>	50
FA40004_9005	<b>1.18" x 2.95" batten cap, RAL 9005</b>	50
FA40004_9010	<b>1.18" x 2.95" batten cap, RAL 9010</b>	50
FA40004_EXC	<b>1.18" x 2.95" batten cap, Exclusive digital printed wood-grain decoration</b>	50



		Qty per bag
FA30018	<b>hanging wire with spring for suspended ceilings</b>	1



		Qty per bag
FA30019	<b>hanging wire with open eyelet for suspended ceilings</b>	1